

TROY



A C U T A B O V E U N E C O U P E S U P E R I E U R E

A CUT ABOVE UNE COUPE SUPÉRIEURE

A C U T A B O V E U N E C O U P E S U P E R I E U R E

2023

DECORATION / DÉCORATION	4
PRACTICE / PRATIQUE	12
TJ-10	12
TJ-88	13
TJ-80	14
TJ-281	15
TJ-290	16
GAME / MATCH	18
TJ-300	18
SOCKS / BAS	24
SK-80	24
SK-100	25
SK-200	26
SK-300	32
BASEBALL / BASEBALL	35
TJ-680	36
ACCESSORIES / ACCESSOIRES	37
TJ-675	37
TJ-910	37
Gear Racks/Supports de séchage	38
CUSTOM / SUR MESURE	40
Custom/Sur mesure TJ-310/SK-310/TP-310	42
Sublimation TJ-601/TJ-620/TJ-625	44
Hybrid/Hybride TJ-80/TJ-300	47
Kits/Ensembles	48
Special events/Événements spéciaux	49
Reversibles/Réversibles	50
Dek TJ-610/TP-611	51
Baseball BB-650	52
Hoodies	53
Various/Varié	54
Bags/Sacs	59
Sublimation (specifications)	60





A C U T A B O V E U N E C O U P E S U P E R I E U R E

A CUT ABOVE UNE COUPE SUPÉRIEURE

A C U T A B O V E U N E C O U P E S U P E R I E U R E

OUR TEAM

is prepared to provide your team with the best options whether it's from inventory or custom-made. Look like the pros or stand out on your own; our experienced staff will put you **One Cut Above!**

Our design staff will customize hockey jerseys, socks, pant shells as well as hoodies, jackets and baseball shirts! Follow our easy-to-use program to suit your needs.

NOTRE ÉQUIPE

est prête à fournir à VOTRE ÉQUIPE les meilleures options, que ce soit des articles en inventaire ou personnalisés. Ressemblez aux pros ou démarquez-vous; notre personnel d'expérience qualifié saura vous mettre un **Cran Au-Dessus!**

Notre personnel de design personnalise des chandails, des bas, et des gaines de hockey ainsi que les survêtements et des chandails de baseball! Suivez notre programme facile d'utilisation selon vos besoins.



DECORATION LEVEL 1

VINYL; SILKSCREEN; DIGITAL
DELIVERY TIME : 3 WEEKS

MINIMUM ORDER: 12 pcs

DÉCORATION NIVEAU 1

VINYLE; SÉRIGRAPHIE; NUMÉRIQUE
DÉLAI DE LIVRAISON : 3 SEMAINES

COMMANDE MINIMUM: 12 mcx



VINYL / VINYLE



SILKSCREEN / SÉRIGRAPHIE



DIGITAL / NUMÉRIQUE

Compatible with / Compatible avec



TJ-10

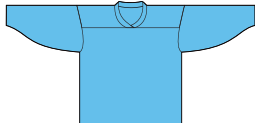

TJ-80



TJ-281



TJ-290



TJ-300



TJ-680

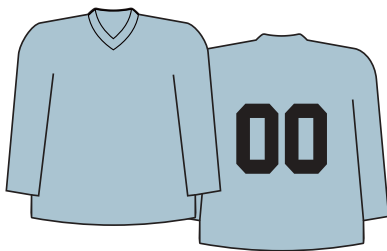

1-color vinyl numbers
Numéros en vinyle 1-couleur

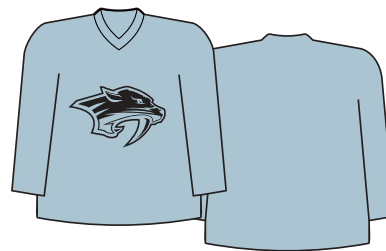

1-color logo
Logo 1-couleur

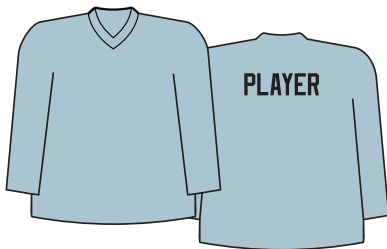

1-color vinyl player name
*Nom de joueur en vinyle
1-couleur*

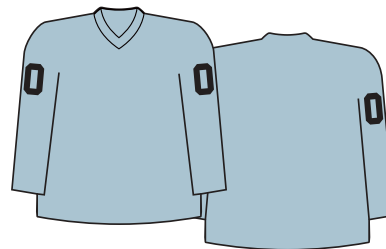

1-color logo sleeve numbers
*Numéros aux manches
en vinyle 1-couleur*

For Association pricing contact TROY Apparel
Pour prix pour association contacté TROY Apparel

DECORATION LEVEL 2

VINYL; SILKSCREEN; DIGITAL
DELIVERY TIME : 3 WEEKS

MINIMUM ORDER: 12 pcs
-RE ORDER: Min. 6 pcs

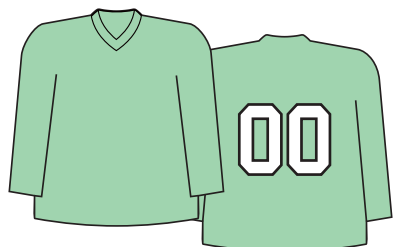

Multicolor numbers
Numéros multicolore

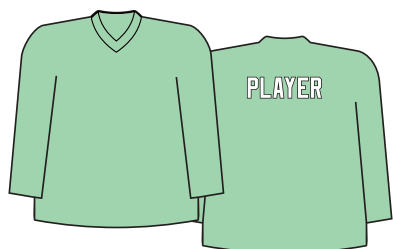

Multicolor player name
Nom de joueur multicolore



Multicolor logo
Logo multicolore

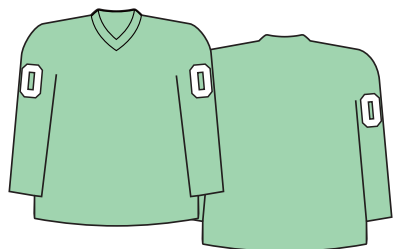

Multicolor sleeve numbers
Numéros aux manches multicolores

DÉCORATION NIVEAU 2

VINYLE; SÉRIGRAPHIE; NUMÉRIQUE
DÉLAI DE LIVRAISON : 3 SEMAINES

COMMANDE MINIMUM: 12 mcx
-COMMANDE A NOUVEAU: Min.6 mcx





DECORATION LEVEL 3

SUBLIMATION & DIGITAL ON TWILL
DELIVERY TIME: 3 WEEKS

MINIMUM ORDER: 12 pcs
-RE ORDER: Min. 6 pcs



SUBLIMATION ON TWILL / SUBLIMATION SUR TWILL

DÉCORATION NIVEAU 3

SUBLIMATION & NUMÉRIQUE SUR TWILL
DÉLAI DE LIVRAISON: 3 SEMAINES

COMMANDE MINIMUM: 12 mcx
-COMMANDE A NOUVEAU: Min. 6 mcx



DIGITAL ON TWILL / NUMÉRIQUE SUR TWILL

NOTE:
TWILL LOGOS & NUMBERS
ARE SEWN ON.

À NOTER:
LOGOS & NUMÉROS
TWILL SONT COUSUS.

Compatible with / Compatible avec



TJ-281



TJ-290



TJ-300



Multicolor number on twill
Numéros multicolores sur twill



Multicolor logo on twill
Logos multicolores sur twill

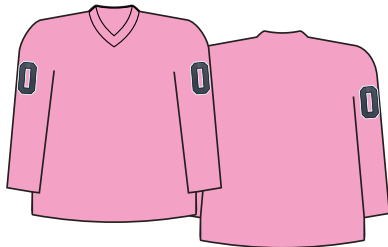

Multicolor sleeve numbers on twill
Numéros aux manches multicolores sur twill

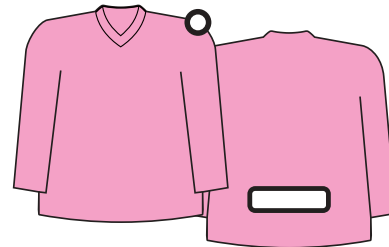

Multicolor sponsor logos on twill
Logos de commanditaires multicolores sur twill

DECORATION LEVEL 4

EMBROIDERY
DELIVERY TIME: 6 WEEKS

MINIMUM ORDER: 12 pcs
-RE ORDER: Min. 6 pcs

DÉCORATION NIVEAU 4

BRODERIE
DÉLAI DE LIVRAISON: 6 SEMAINES

COMMANDE MINIMUM: 12 mcx
-COMMANDE A NOUVEAU: Min. 6 mcx



EMBROIDERY / BRODERIE

NOTE:
LOGOS MAY INCLUDE TWILL.
TWILL NUMBERS ARE SEWN ON.
*ALL SET UP COSTS INCLUDED IN PRICE.

À NOTER:
LES LOGOS PEUVENT INCLURE DU TWILL
LES NUMÉROS EN TWILL SONT COUSUS.
*TOUS LES FRAIS D'INSTALLATION INCLUS DANS LE PRIX

Compatible with / Compatible avec



TJ-281



TJ-290



TJ-300



TJ-680



Embroidered logo
Logo brodé



1-color twill numbers
Numéros en twill 1-couleur

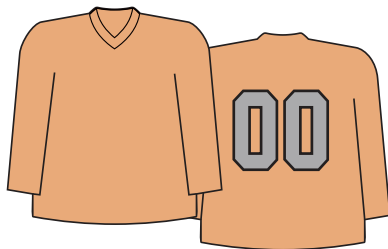

2-color twill numbers
Numéros en twill 2-couleurs

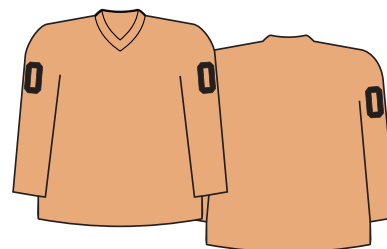

1-color sleeve twill numbers
Numéros aux manches en twill 1-couleur

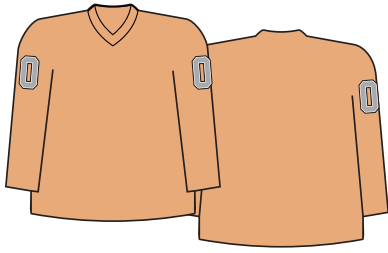

2-color sleeve twill numbers
Numéros aux manches en twill 2-couleurs



1-color twill player name on band
Nom de joueur en twill 1-couleur sur bande



2-color twill player name on band
Nom de joueur en twill 2-couleurs sur bande

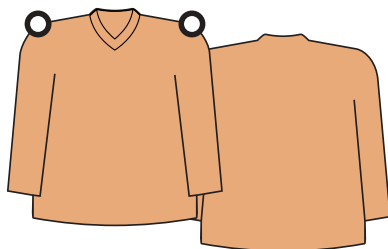

Embroidered sponsor logos
Logos de commanditaires brodés



COLORS // COULEURS

NOTE: Vinyl colors are limited to suppliers' stock.

IMPORTANT: **TROY Apparel** does its best to match colors for digital prints requested by customers.

À NOTER: Les couleurs en vinyle sont limitées par les inventaires de nos fournisseurs.

IMPORTANT: **TROY Apparel** fait de son mieux pour faire correspondre les couleurs des impressions numériques requis par les clients.

RED/ROUGE	WHITE/BLANC	GREEN/VERT	MAROON/BORDEAUX	BLACK/NOIR
ROYAL/ROYAL	GOLD/OR	NAVY/MARINE	ORANGE/ORANGE	SKY/CIEL
FOREST/FORÊT	SILVER/ARGENT	PURPLE/VIOLET	VEGAS GOLD/OR VEGAS	PINK/ROSE
TEAL/SARCELLE	HARVARD/HARVARD			

NUMBERS // NUMÉROS

TROY Apparel stock vinyl numbers available only in White, Black, Navy and Royal in 10 inch.

*All 32 NHL team font styles are available for a surcharge.

Les chiffres **TROY Apparel** en stock comprennent uniquement des numéros de vinyle en noir, blanc, bleu marin et bleu royal de 10 pouces.

*Les chiffres et lettrage de les 32 équipes de la LNH sont disponibles pour un frais additionnel.

TROY APPAREL stock vinyl numbers
Chiffres TROY APPAREL en vinyle

1 2 3 4 5 6 7 8 9 0

SUGGESTIONS / SUGGESTIONS

TN-01 **1 2 3 4 5 6 7 8 9 10**

TN-02 **1 2 3 4 5 6 7 8 9 10**

TN-03 **1 2 3 4 5 6 7 8 9 10**

TN-04 **1 2 3 4 5 6 7 8 9 10**

TN-05 **1 2 3 4 5 6 7 8 9 10**

TN-06 **1 2 3 4 5 6 7 8 9 10**

TN-07 **1 2 3 4 5 6 7 8 9 10**

TN-08 **1 2 3 4 5 6 7 8 9 10**

TN-09 **1 2 3 4 5 6 7 8 9 10**

TN-10 **1 2 3 4 5 6 7 8 9 10**

TN-11 **1 2 3 4 5 6 7 8 9 10**

TN-12 **1 2 3 4 5 6 7 8 9 10**

SPECIFICATIONS // SPÉCIFICATIONS

LOGOS & NUMBERS

Guideline for placement(s)

LOGOS & NUMÉROS

Guide pour placement(s)

VINYL	VINYLE
SILKSCREEN	SÉRIGRAPHIE
DIGITAL TRANSFERS	TRANSFERES DIGITALE
TWILL	TWILL
EMBROIDERY	BRODERIE
SUBLIMATION	SUBLIMATION

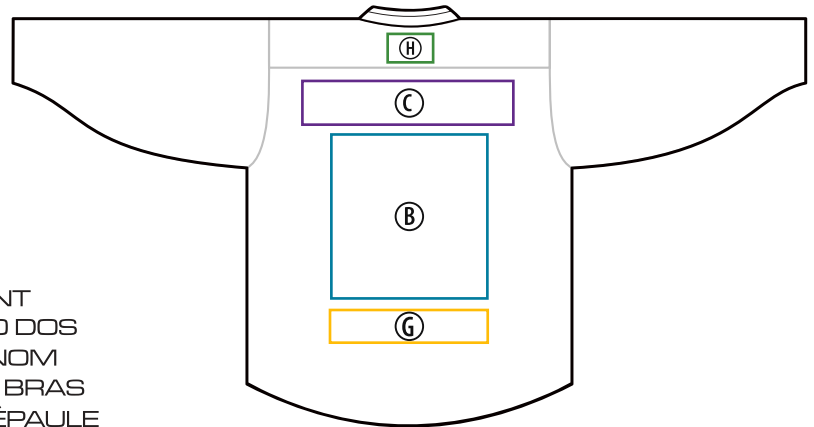
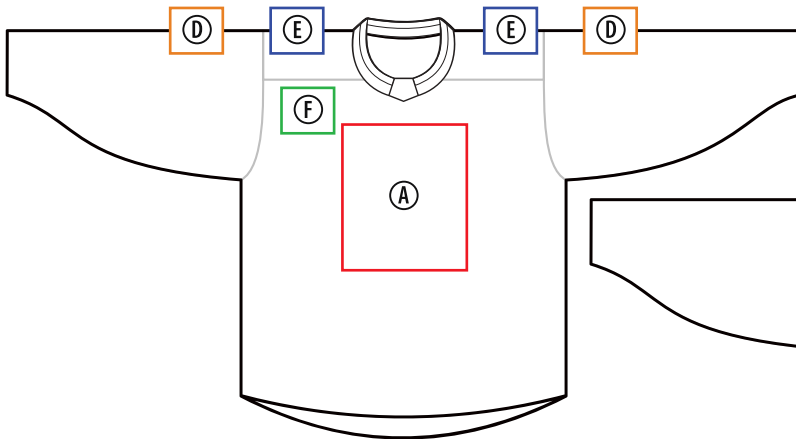

- A: FRONT LOGO / LOGO AVANT
- B: BACK NUMBER / NUMÉRO DOS
- C: NAME BAR / PLAQUE DE NOM
- D: ARM NUMBER / NUMÉRO BRAS
- E: SHOULDER LOGO / LOGO ÉPAULE
- F: CHEST LOGO / LOGO POITRINE
- G: SPONSOR BAR / COMMANDITAIRE
- H: STOP SIGN / PANNEAU D'ARRÊT

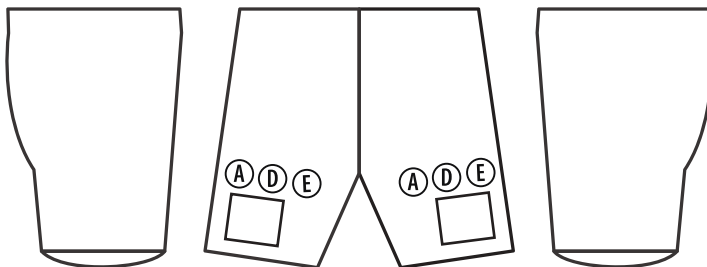

- A: MAIN LOGO / LOGO PRINCIPAL
- D: NUMBER / NUMÉRO
- E: SECONDARY LOGO / LOGO SECONDAIRE

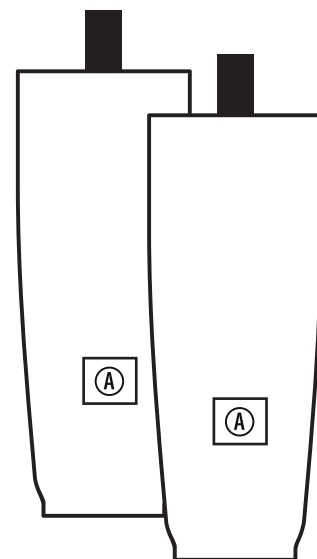

- A: MAIN LOGO / LOGO PRINCIPAL

TJ-10 PINNIE / DOSSARD

- 100% polyester
- Contrast piping
- Fits over equipment



- 100% polyester
- Garniture contrastante
- Recouvre l'équipement

SIZES // TAILLES

JR, INT., SR

TJ-10



03 RED/ROUGE



04 WHITE/BLANC



08 GREEN /VERT



11 MAROON/BORDEAUX



13 BLACK/NOIR



14 ROYAL/ROYAL



16 GOLD/OR



17 NAVY/MARINE



28 SKY/CIEL



30 FOREST/FOÛRET



40 PINK/ROSE



45 PURPLE/VIOLET



55 AQUA/ AQUA





TJ-88 REVERSIBLE / REVERSIBLE



- 100% polyester
- 2-in-1 color

- 100% polyester
- Couleur 2-en-1

SIZES // TAILLES

JR: S/M, L/XL, G, INT. G

SR: S, M, L, XL, 2XL, G

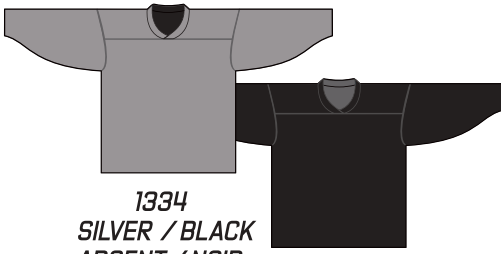

1334
SILVER / BLACK
ARGENT / NOIR

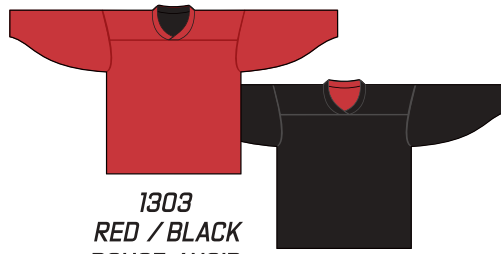

1303
RED / BLACK
ROUGE / NOIR

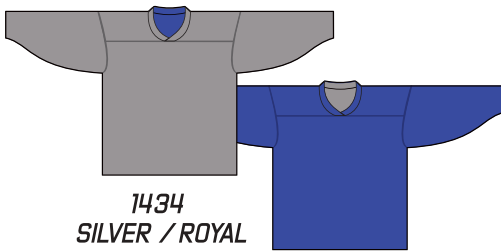

1434
SILVER / ROYAL
ARGENT / ROYAL



1704
WHITE / NAVY
BLANC / MARINE

NEW COLOR
NOUVELLE COULEUR

IMPORTANT

Only heat transfer decorations are possible.
PRICE INCLUDES DECORATION ON BOTH SIDES

IMPORTANT

Seulement les décorations par transfert thermique sont possibles.
LA DÉCORATION DES DEUX CÔTÉS EST INCLUS DANS LE PRIX

TJ-80 JERSEY / CHANDAIL

- 100% lightweight polyester
- Solid color

- 100% polyester léger
- Couleur unie

SIZES // TAILLES

JR: XS, S/M, L/XL, G, INT. G

SR: S, M, L, XL, 2XL, G

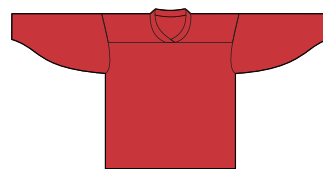

1003 RED/ROUGE



1004 WHITE/BLANC



1008 GREEN /VERT

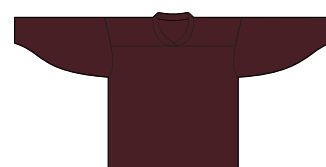

1011 MAROON/BORDEAUX



1013 BLACK/NOIR

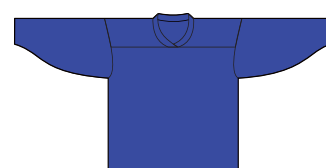

1014 ROYAL/ROYAL

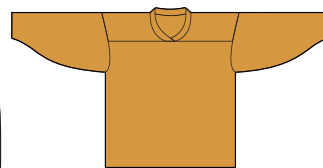

1015 VEGAS GOLD/OR VEGAS

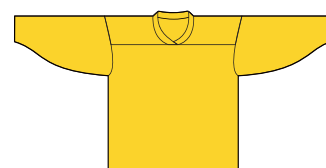

1016 GOLD/OR



1017 NAVY /MARINE

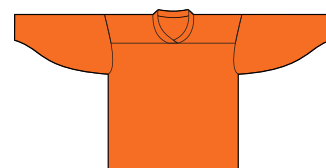

1022 ORANGE/ORANGE

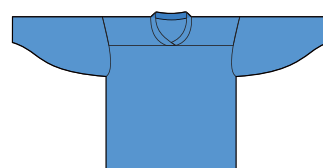

1028 SKY /CIEL



1030 FOREST/FÔRET

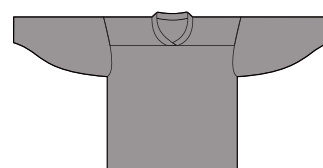

1034 SILVER/ARGENT

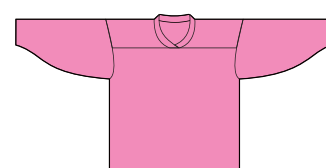

1040 PINK/ROSE

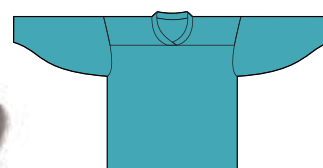

1042 TEAL/SARCELLE



1045 PURPLE/VIOLET

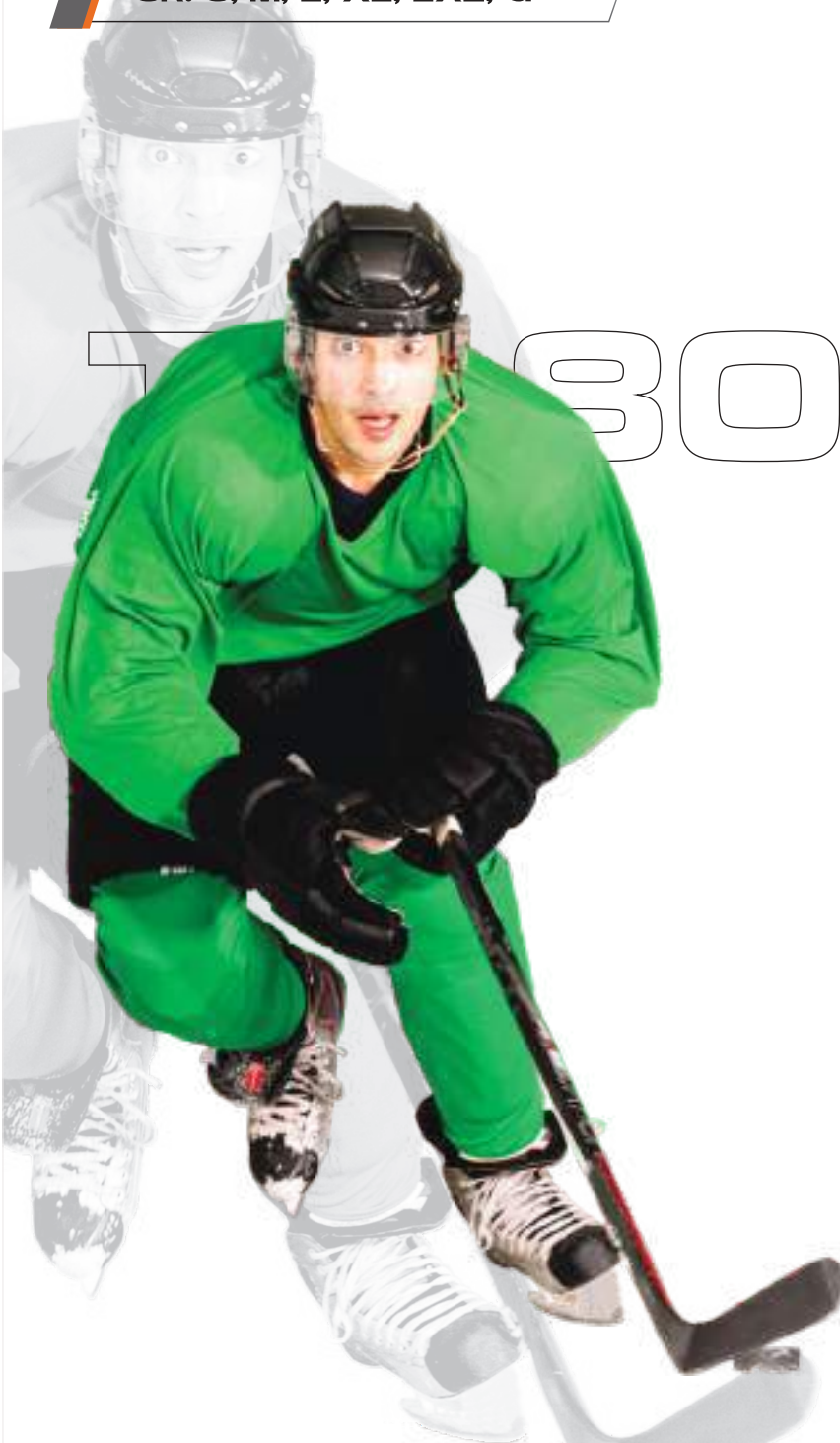

TJ-281 JERSEY / CHANDAIL

- 100% polyester
- Contrasting panels
- Ergonomic fit
- 100% polyester
- Panneaux contrastants
- Coupe ergonomique

SIZES // TAILLES

JR: S/M, L/XL, G
 SR: S, M, L, XL, 2XL, G



1003 RED/ROUGE



1004 WHITE/BLANC



1008 GREEN/VERT



1013 BLACK/NOIR



1014 ROYAL/ROYAL



1016 GOLD/OR



1017 NAVY/MARINE



1022 ORANGE/ORANGE



1028 SKY/CIEL



1034 SILVER/ARGENT



TJ-290 JERSEY / CHANDAIL

- 100% heavyweight polyester
- Double shoulders and elbows
- Contrasting panels

- 100% Polyester robuste
- Épaules et coudes doublés
- Panneaux contrastants

SIZES // TAILLES

JR: S/M, L/XL, G

SR: S, M, L, XL, 2XL, G

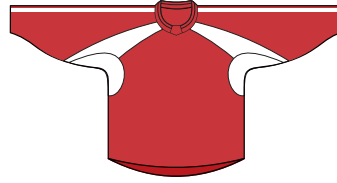

1003 RED/WHITE
ROUGE/BLANC

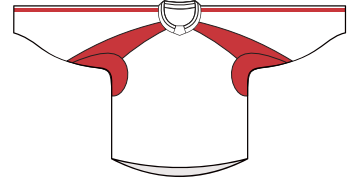

0403 WHITE/RED
BLANC/ROUGE



1008 GREEN/WHITE
VERT/BLANC

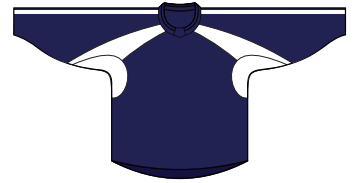

1017 NAVY/WHITE
MARINE/BLANC

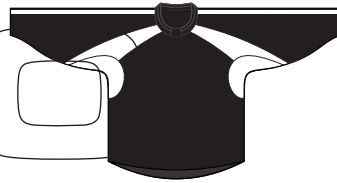

1013 BLACK/WHITE
NOIR/BLANC

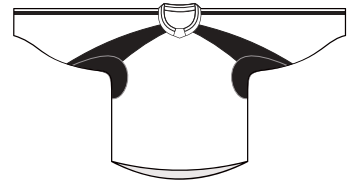

1004 WHITE/BLACK
BLANC/NOIR



1014 ROYAL/WHITE
ROYAL/BLANC

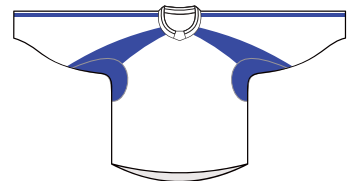

0414 WHITE/ROYAL
BLANC/ROYAL



1016 GOLD/BLACK
OR/NOIR

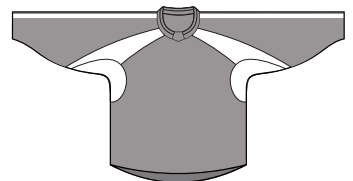

1034 SILVER/WHITE
ARGENT/BLANC



TJ-290



TROY



A C U T A B O V E U N E C O U P E S U P E R I E U R E

TJ-300 PRO REPLICA / RÉPLIQUE PRO

- PERFORMANCE Hygro-Fit 100% heavyweight polyester
- Double shoulders and elbows
- NEW: Air-mesh fabric on shoulders (2022 models only.)
- Tissu PERFORMANCE Hygro-Fit 100% polyester robuste
- Épaules et coudes doublés
- NOUVEAU: Tissus 'air-mesh' sur les epaules (Modèles 2022 seul).

SIZES // TAILLES

JR: S/M, L/XL, G

SR: S, M, L, XL, 2XL, G

2020-2022 jerseys have no fight strap.

NOTE: SK-300 SOCKS SHOWN FOR REFERENCE ONLY.

Chandails 2020-2022 sont sans lanière de combat.

À NOTER: LES BAS SK-300 SONT PRÉSENTÉ À TITRE DE RÉFÉRENCE SEULEMENT.

BUFFALO 3133



SK-300-3133

BUFFALO 3134



SK-300-3134

MONTREAL 3053



SK-300-3053

NEW / NOUVEAU
2022



TJ-300 PRO REPLICA / RÉPLIQUE PRO

NEW / NOUVEAU
2022

CALGARY 3323



SK-300-3323

CALGARY 3324



SK-300-3324

COLORADO 3663



SK-300-3663

NEW COLOR
MID BLUE
NOUVELLE COULEUR
BLEU MOYEN

COLORADO 3664



SK-300-3664

NEW COLOR
MID BLUE
NOUVELLE COULEUR
BLEU MOYEN

OTTAWA 3225



SK-300-3225

OTTAWA 3226



SK-300-3352

OTTAWA 3227



SK-300-3227

WINNIPEG 3603



SK-300-3603

NEW COLOR
MID BLUE
NOUVELLE COULEUR
BLEU MOYEN

TJ-300 PRO REPLICA / RÉPLIQUE PRO

ANAHEIM 3551



SK-300-3551

ANAHEIM 3552



SK-300-3552

ARIZONA 3621



SK-300-3621

ARIZONA 3622



SK-300-3622

BOSTON 3021



SK-300-3021

BOSTON 3022



SK-300-3022

BOSTON 3023



SK-300-3023

CAROLINA 3673



SK-300-3673

TROY APPAREL.COM

CAROLINA 3674



SK-300-3674

CAROLINA 3675



SK-300-3675

CHICAGO 3011



SK-300-3011

CHICAGO 3012

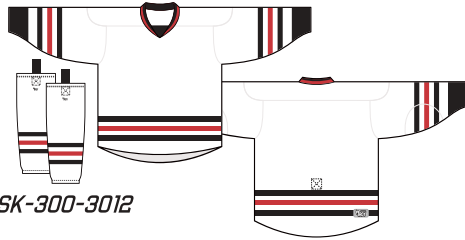

SK-300-3012

CHICAGO 3013



SK-300-3013

COLUMBUS 3701



SK-300-3701

COLUMBUS 3702



SK-300-3702

DALLAS 3431



SK-300-3431

DALLAS 3432



SK-300-3432

DETROIT 3061



SK-300-3061

DETROIT 3062



SK-300-3062

EDMONTON 3241



SK-300-3241

EDMONTON 3242



SK-300-3242

EDMONTON 3243



SK-300-3243

FLORIDA 3381



SK-300-3381

FLORIDA 3382



SK-300-3382

HARTFORD 3471



SK-300-3471

LOS ANGELES 3124



SK-300-3121

LOS ANGELES 3125

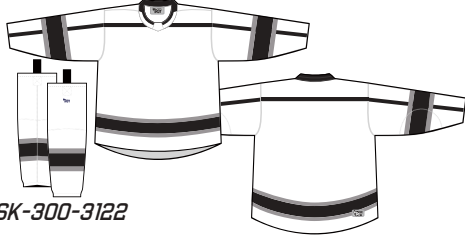

SK-300-3122

LOS ANGELES 3126

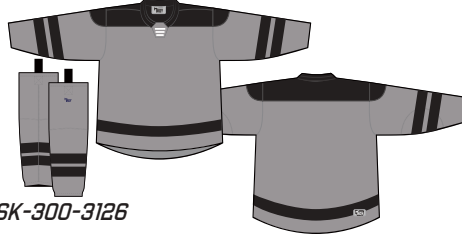

SK-300-3126

MINNESOTA 3721



SK-300-3721

MINNESOTA 3722



SK-300-3722

MONTREAL 3051



SK-300-3051

MONTREAL 3052



SK-300-3052

NASHVILLE 3683



SK-300-3683

NASHVILLE 3684

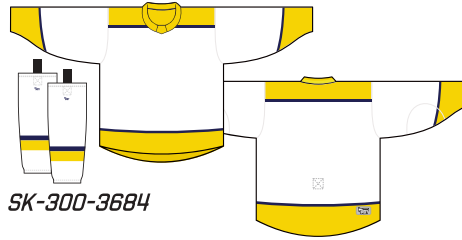

SK-300-3684

NEW JERSEY 3351



SK-300-3351

TJ-300 PRO REPLICA / RÉPLIQUE PRO

NEW JERSEY 3352



SK-300-3352

NY ISLANDERS 3153



SK-300-3153

NY ISLANDERS 3154



SK-300-3154

NY RANGERS 3031



SK-300-3031

NY RANGERS 3032



SK-300-3032

PHILADELPHIA 3111



SK-300-3111

PHILADELPHIA 3112



SK-300-3112

PHILADELPHIA 3113



SK-300-3113

PITTSBURGH 3333



SK-300-3333

PITTSBURGH 3334



SK-300-3334

PITTSBURGH 3335



SK-300-3335

PITTSBURGH 3336



SK-300-3336

SAN JOSE 3201



SK-300-3201

SAN JOSE 3202



SK-300-3202

ST-LOUIS 3091



SK-300-3091

ST-LOUIS 3092



SK-300-3092

SEATTLE 3751



SK-300-3751

SEATTLE 3752



SK-300-3752

TAMPA BAY 3231



SK-300-3231

TAMPA BAY 3232

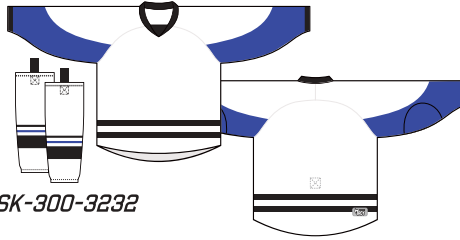

SK-300-3232

TORONTO 3041



SK-300-3041

TORONTO 3042



SK-300-3042

VANCOUVER 3343



SK-300-3343

VANCOUVER 3344



SK-300-3344



HYGRO-FIT

Hygrosopic Fabric Tissus Hygrosopique

Keeps you dry & comfortable during play.

Hygrosopic fabric's moisture transferring technology moves and disperses sweat away from the body so it can evaporate quickly.

Vous garde au sec et confortable pendant l'activité physique.

Le tissu Hygrosopique est une technologie de transfert d'humidité. La sueur du corps se déplace et se dissipe vers l'extérieur pour s'évaporer rapidement.

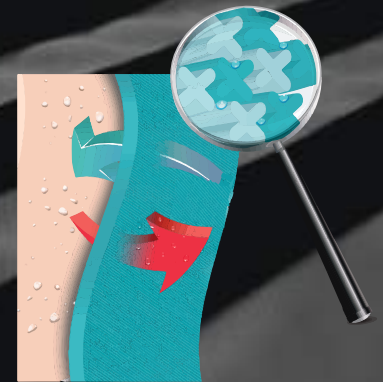

VEGAS 3731



SK-300-3731

VEGAS 3732



SK-300-3732

WASHINGTON 3271



SK-300-3271

WASHINGTON 3272



SK-300-3272

WINNIPEG 3601



SK-300-3601

WINNIPEG 3602



SK-300-3602

SK-80 KNIT SOCKS / BAS EN TRICOT



- Polycotton blend
- Elasticized ankle
- Composition polycoton
- Cheville élastique

IMPORTANT

Dye lots may vary on knitted socks

Les lots de teinture peuvent varier sur les bas tricotés

SIZES // TAILLES

20", 24", 28", 32"

RETAIL PACKAGES AVAILABLE UPON REQUEST

FORFAITS DE VENTE AU DÉTAIL DISPONIBLES SUR DEMANDE

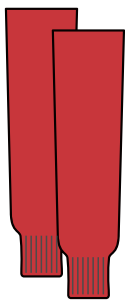

03 RED
ROUGE

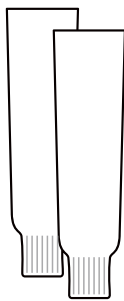

04 WHITE
BLANC

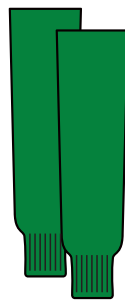

08 GREEN
VERT

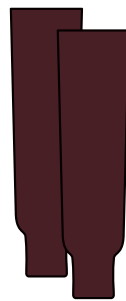

11 MAROON
BORDEAUX



13 BLACK
NOIR

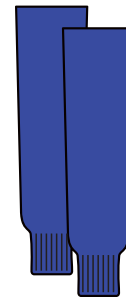

14 ROYAL
ROYAL

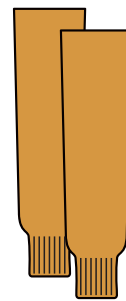

15 VEGAS GOLD
OR VEGAS

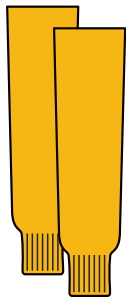

16 GOLD
OR

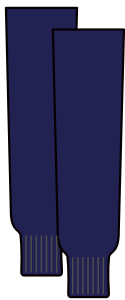

17 NAVY
MARINE

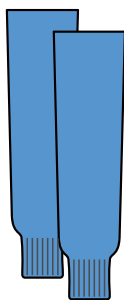

28 SKY
CIEL

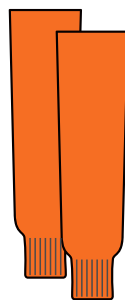

22 ORANGE
ORANGE



30 FOREST
FÔRET

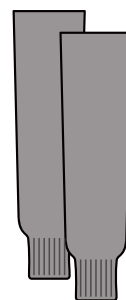

34 SILVER
ARGENT

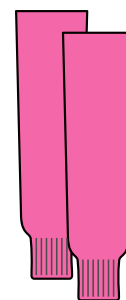

40 PINK
ROSE

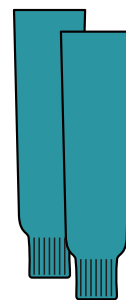

42 TEAL
SARCELLE

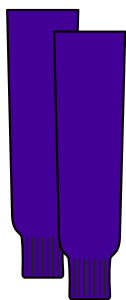

45 PURPLE
VIOLET

SK-100 PRO PERFORMANCE / PERFORMANCE PRO

- 100% heavyweight Hygro-Fit polyester
- Elasticized ankle
- Two velcro straps
- Tissu Hygro-Fit 100%, polyester robuste
- Cheville élastique
- Deux attaches en velcro

SIZES // TAILLES

JR: 20" - 22"

INT.: 24" - 26"

SR: 28" - 30"

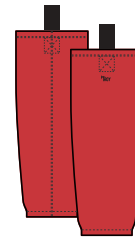

03 RED
ROUGE

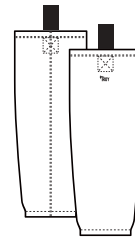

04 WHITE
BLANC

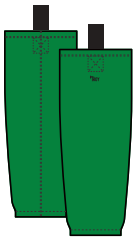

08 GREEN
VERT



11 MAROON
BORDEAUX



13 BLACK
NOIR

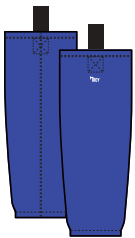

14 ROYAL
ROYAL

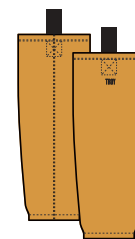

15 VEGAS GLD
OR VEGAS

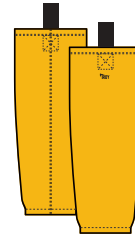

16 GOLD
OR

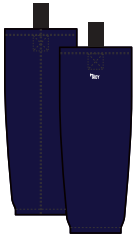

17 NAVY
MARINE

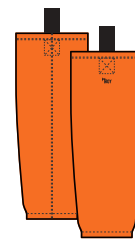

22 ORANGE
ORANGE

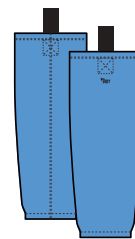

28 SKY
CIEL

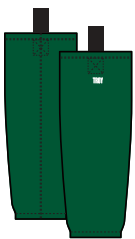

30 FOREST
FORÊT

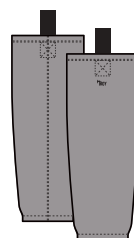

34 SILVER
ARGENT

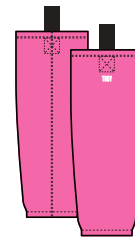

40 PINK
ROSE

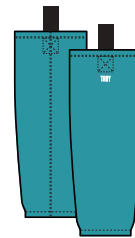

42 TEAL
SARCELLE

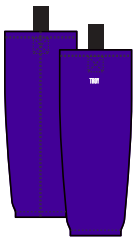

45 PURPLE
VIOLET

SK-1000



SK-200 KNIT SOCKS / BAS EN TRICOT



- Polycotton blend
- Elasticized ankle
- Composition polycoton
- Cheville élastique

IMPORTANT

Dye lots may vary on knitted socks

Les lots de teinture peuvent varier sur les bas tricotés

SIZES // TAILLES

20", 24", 28", 32"

RETAIL PACKAGES AVAILABLE UPON REQUEST

FORFAITS DE VENTE AU DÉTAIL DISPONIBLES SUR DEMANDE

32 NHL TEAMS AVAILABLE

32 ÉQUIPES DE LA LNH DISPONIBLES



ANAHEIM
SK-200-3551



ANAHEIM
SK-200-3552

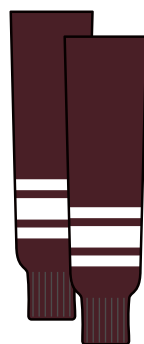

ARIZONA
SK-200-3621

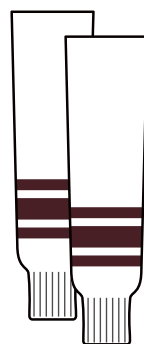

ARIZONA
SK-200-3622

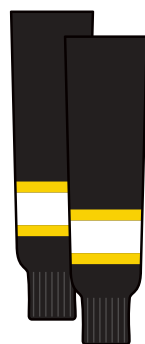

BOSTON
SK-200-3021



BOSTON
SK-200-3022



BOSTON
SK-200-3023



BUFFALO
SK-200-3131

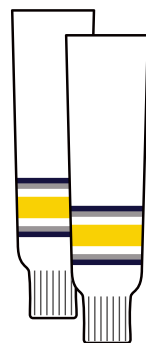

BUFFALO
SK-200-3132

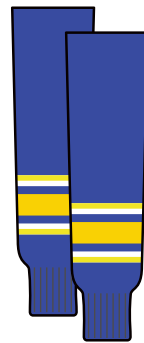

BUFFALO
SK-200-3133

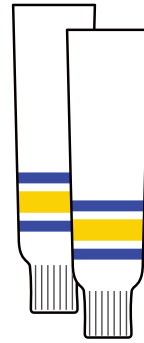

BUFFALO
SK-200-3134



CALGARY
SK-200-3321



CALGARY
SK-200-3322



CALGARY
SK-200-3323



A C U T A B O V E U N E C O U P E S U P É R I E U R E

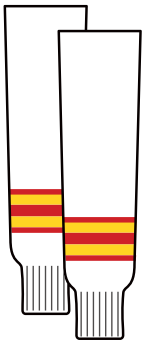

CALGARY
SK-200-3324

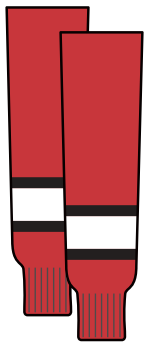

CAROLINA
SK-200-3671



CAROLINA
SK-200-3673

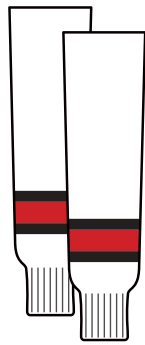

CAROLINA
SK-200-3674



CAROLINA
SK-200-3675



CHICAGO
SK-200-3011

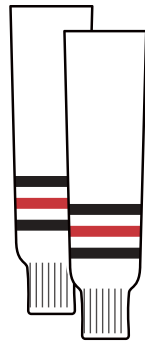

CHICAGO
SK-200-3012



CHICAGO
SK-200-3013

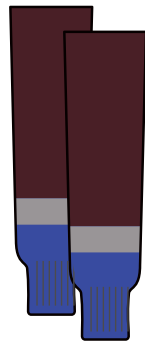

COLORADO
SK-200-3661

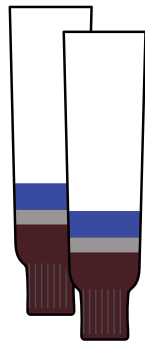

COLORADO
SK-200-3662

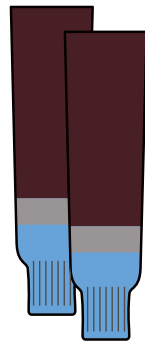

COLORADO
SK-200-3663

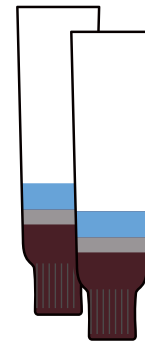

COLORADO
SK-200-3664



COLUMBUS
SK-200-3701

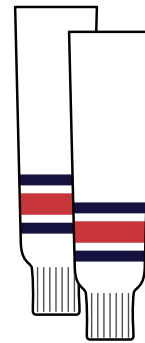

COLUMBUS
SK-200-3702

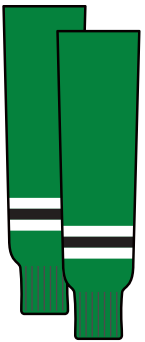

DALLAS
SK-200-3431

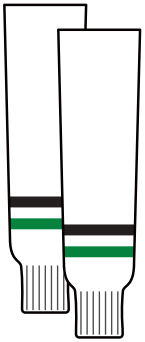

DALLAS
SK-200-3432

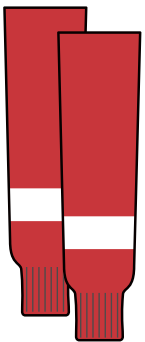

DETROIT
SK-200-3061

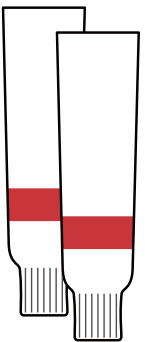

DETROIT
SK-200-3062

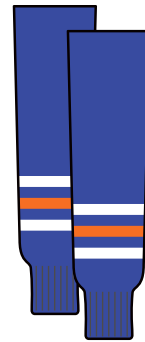

EDMONTON
SK-200-3241

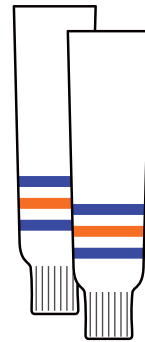

EDMONTON
SK-200-3242

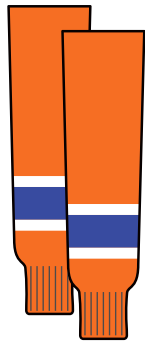

EDMONTON
SK-200-3243

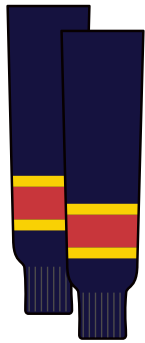

FLORIDA
SK-200-3381

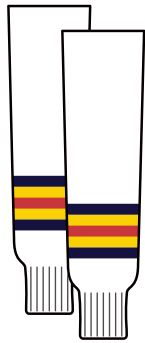

FLORIDA
SK-200-3382



HARTFORD
SK-200-3471

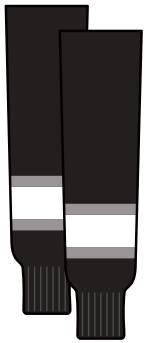

LOS ANGELES
SK-200-3121



LOS ANGELES
SK-200-3122

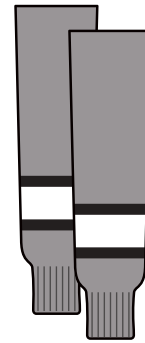

LOS ANGELES
SK-200-3123

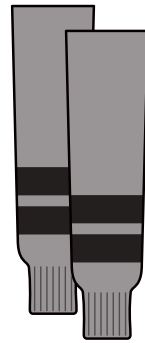

LOS ANGELES
SK-200-3126

SK-200 KNIT SOCKS / BAS EN TRICOT

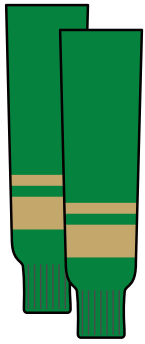

MINNESOTA
SK-200-3721

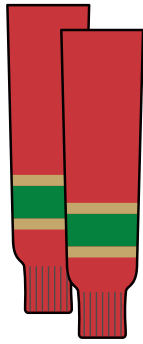

MINNESOTA
SK-200-3722

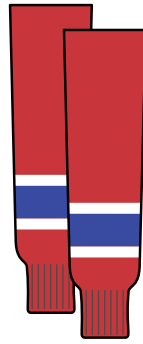

MONTREAL
SK-200-3051

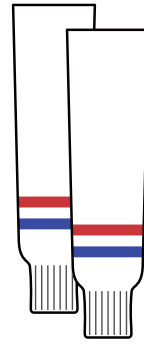

MONTREAL
SK-200-3052

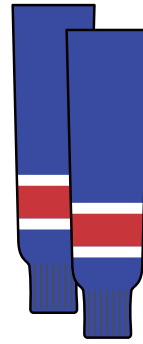

MONTREAL
SK-200-3053

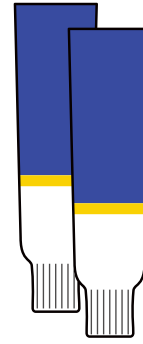

NASHVILLE
SK-200-3681

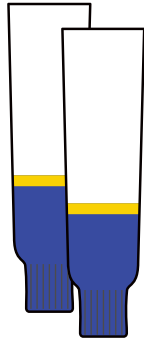

NASHVILLE
SK-200-3682

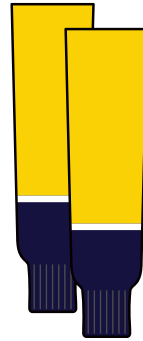

NASHVILLE
SK-200-3683



NASHVILLE
SK-200-3684



NEW JERSEY
SK-200-3351

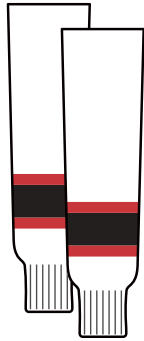

NEW JERSEY
SK-200-3352



NY ISLANDERS
SK-200-3151

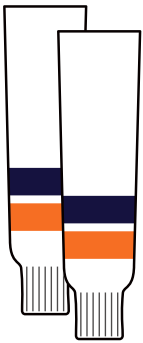

NY ISLANDERS
SK-200-3152

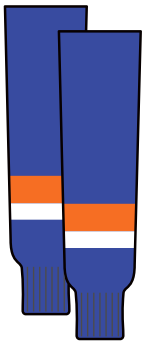

NY ISLANDERS
SK-200-3153

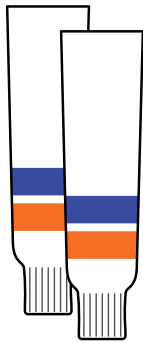

NY ISLANDERS
SK-200-3154

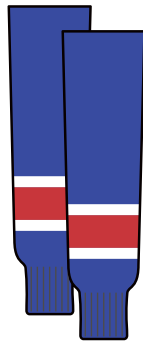

NY RANGERS
SK-200-3031

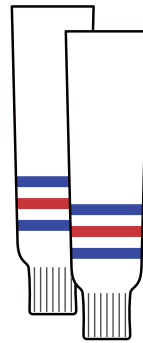

NY RANGERS
SK-200-3032

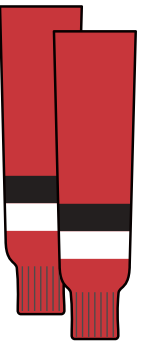

OTTAWA
SK-200-3221

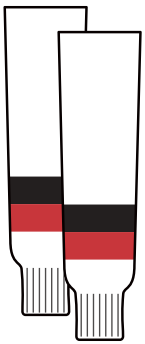

OTTAWA
SK-200-3222

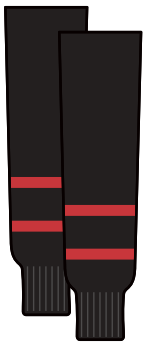

OTTAWA
SK-200-3225

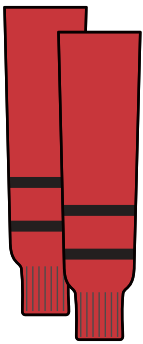

OTTAWA
SK-200-3227



PHILADELPHIA
SK-200-3111

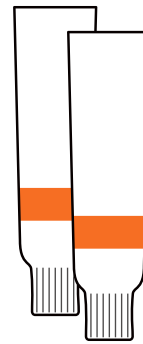

PHILADELPHIA
SK-200-3112



PHILADELPHIA
SK-200-3113

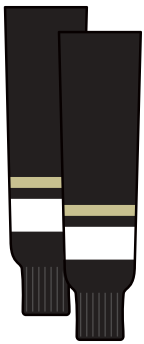

PITTSBURGH
SK-200-3331



A C U T A B O V E U N E C O U P E S U P É R I E U R E

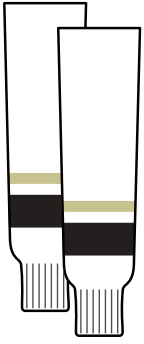

PITTSBURGH
SK-200-3332

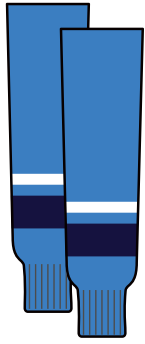

PITTSBURGH
SK-200-3333



PITTSBURGH
SK-200-3334



PITTSBURGH
SK-200-3335



PITTSBURGH
SK-200-3336



SAN JOSE
SK-200-3201



SAN JOSE
SK-200-3202

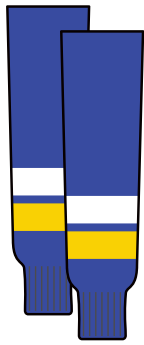

ST-LOUIS
SK-200-3091

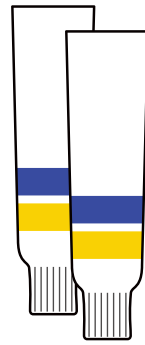

ST-LOUIS
SK-200-3092

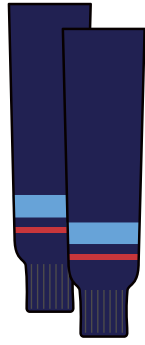

SEATTLE
SK-200-3751

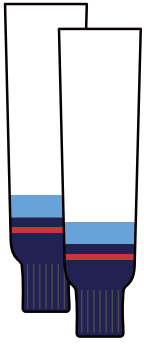

SEATTLE
SK-200-3752



TAMPA BAY
SK-200-3231



TAMPA BAY
SK-200-3232

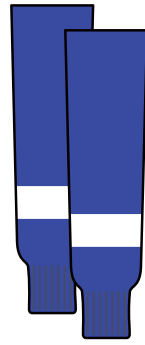

TAMPA BAY
SK-200-3233

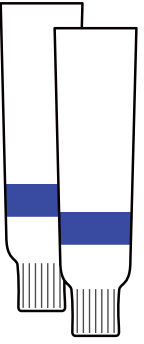

TAMPA BAY
SK-200-3234



TORONTO
SK-200-3041

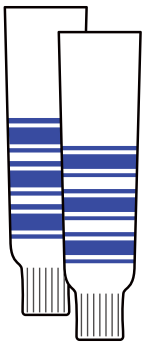

TORONTO
SK-200-3042

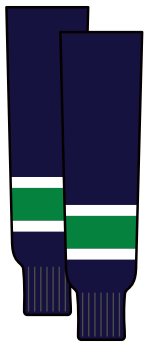

VANCOUVER
SK-200-3341

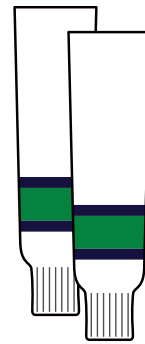

VANCOUVER
SK-200-3342

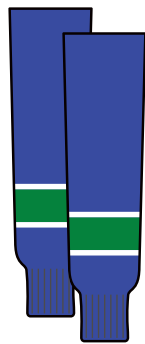

VANCOUVER
SK-200-3343

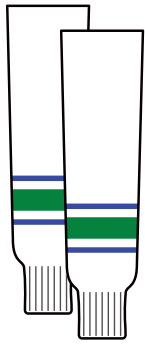

VANCOUVER
SK-200-3344

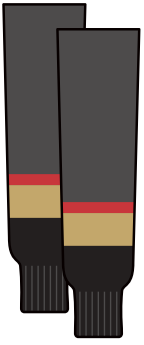

VEGAS
SK-200-3731

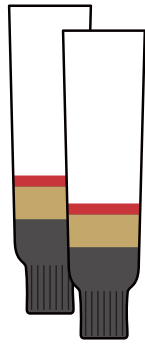

VEGAS
SK-200-3732

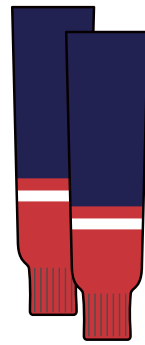

WASHINGTON
SK-200-3271

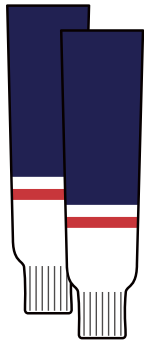

WASHINGTON
SK-200-3272



WINNIPEG
SK-200-3601

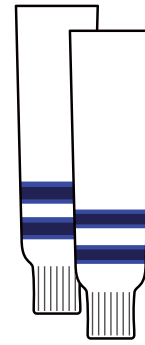

WINNIPEG
SK-200-3602

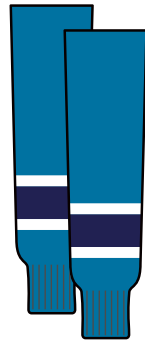

WINNIPEG
SK-200-3603

SK-200 KNIT SOCKS / BAS EN TRICOT



ARMADA
SK-200-3901

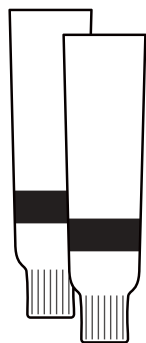

ARMADA
SK-200-3902

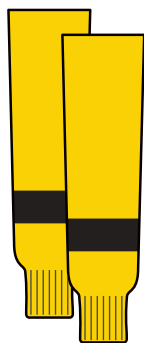

SK-200-1613
GOLD/BLACK
OR/NOIR

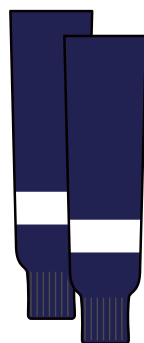

SK-200-1704
NAVY/WHITE
MARINE/BLANC

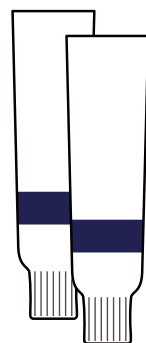

SK-200-0417
WHITE/NAVY
BLANC/MARINE

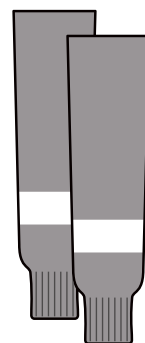

SK-200-3404
SILVER/WHITE
ARGENT/BLANC

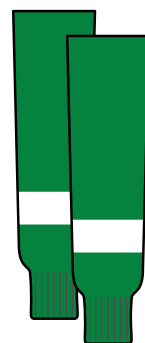

SK-200-0804
GREEN/WHITE
VERT/BLANC

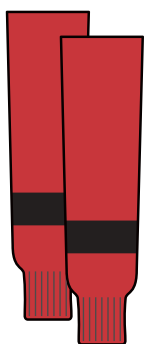

SK-200-0313
RED/BLACK
ROUGE/NOIR

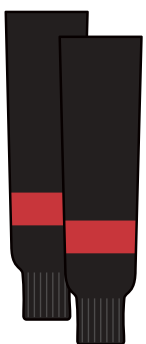

SK-200-1303
BLACK/RED
NOIR/ROUGE

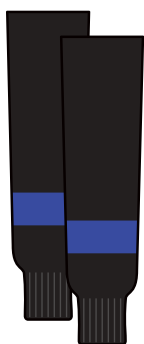

SK-200-1314
BLACK/ROYAL
NOIR/ROYAL

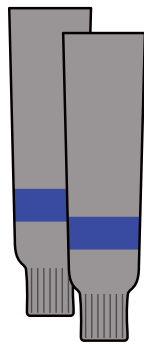

SK-200-3414
SILVER/ROYAL
ARGENT/ROYAL

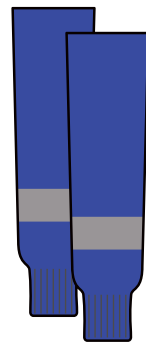

SK-200-1434
ROYAL/SILVER
ROYAL/ARGENT



SK-200-3413
SILVER/BLACK
ARGENT/NOIR



SK-200-1334
BLACK/SILVER
NOIR/ARGENT

CUSTOM SOCKS AVAILABLE

TROY Apparel manufactures all our knit socks in-house. Ask for custom colors to match your team.

GAMME DE BAS CUSTOM DISPONIBLE

TROY Apparel fabrique toutes nos chaussettes en tricot en interne. Demandez des couleurs personnalisées pour correspondre à votre équipe

TROYAPPAREL.COM



A C U T A B O V E U N E C O U P E S U P É R I E U R E



TROY

SK-300 PRO PERFORMANCE / PERFORMANCE PRO

- PERFORMANCE Hygro-Fit
100% heavyweight polyester
- Elasticized ankle
- Two velcro straps

- Tissu PERFORMANCE Hygro-Fit
100% polyester robuste
- Cheville élastique
- Deux attaches en velcro

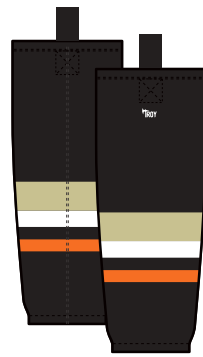

ANAHEIM
SK-300-3551

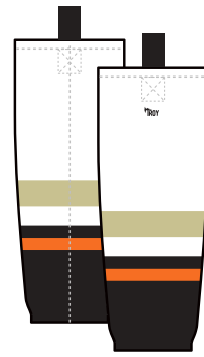

ANAHEIM
SK-300-3552

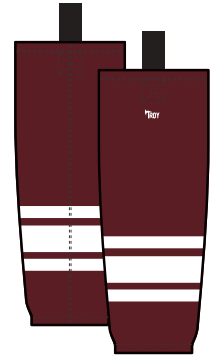

ARIZONA
SK-300-3621

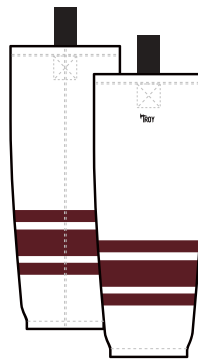

ARIZONA
SK-300-3622



BOSTON
SK-300-3021

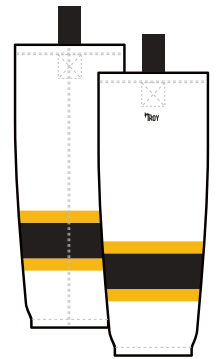

BOSTON
SK-300-3022

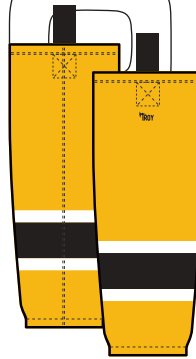

BOSTON
SK-300-3023



BUFFALO
SK-300-3133

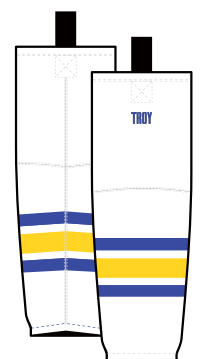

BUFFALO
SK-300-3134



CALGARY
SK-300-3321

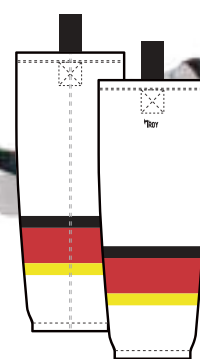

CALGARY
SK-300-3322



CALGARY
SK-300-3323

SIZES // TAILLES

JR: 20" - 22"
INT.: 24" - 26"
SR: 28" - 30"



32 NHL TEAMS AVAILABLE
32 ÉQUIPES DE LA LNH DISPONIBLES

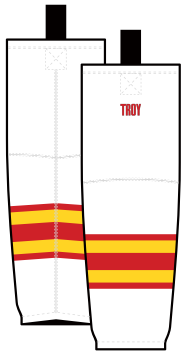

CALGARY
SK-300-3324

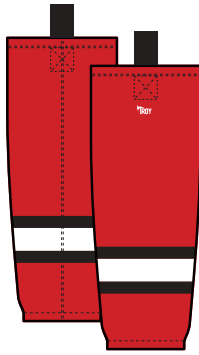

CAROLINA
SK-300-3671



CAROLINA
SK-300-3673

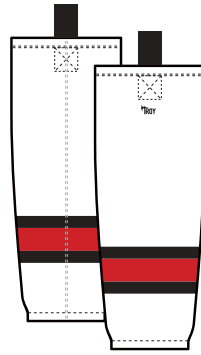

CAROLINA
SK-300-3674

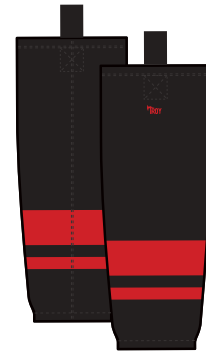

CAROLINA
SK-300-3675

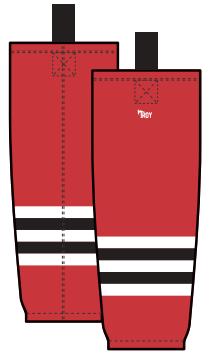

CHICAGO
SK-300-3011

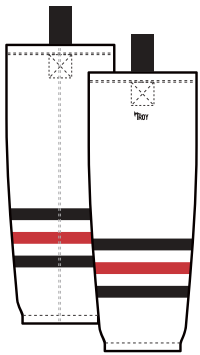

CHICAGO
SK-300-3012

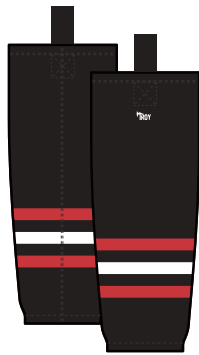

CHICAGO
SK-300-3013

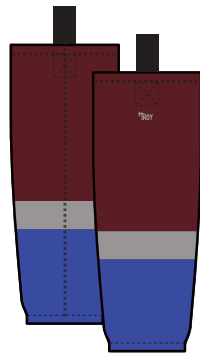

COLORADO
SK-300-3661

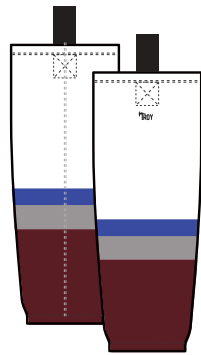

COLORADO
SK-300-3662



COLORADO
SK-300-3663



COLORADO
SK-300-3664

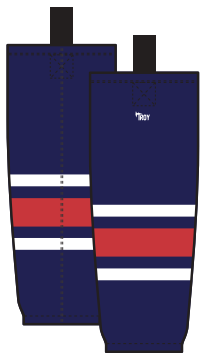

COLUMBUS
SK-300-3701

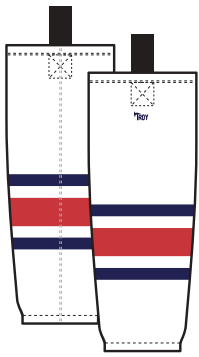

COLUMBUS
SK-300-3702

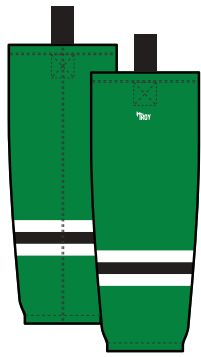

DALLAS
SK-300-3431

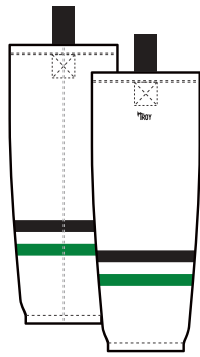

DALLAS
SK-300-3432

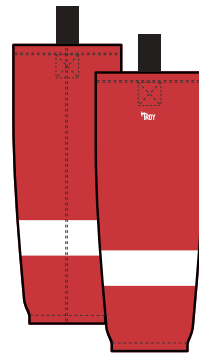

DETROIT
SK-300-3061

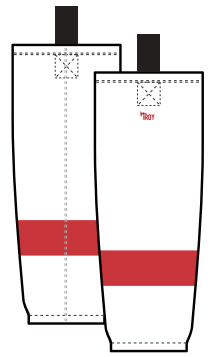

DETROIT
SK-300-3062

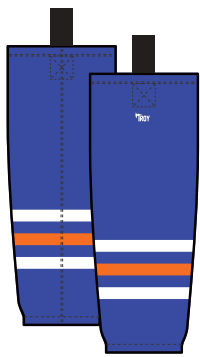

EDMONTON
SK-300-3241

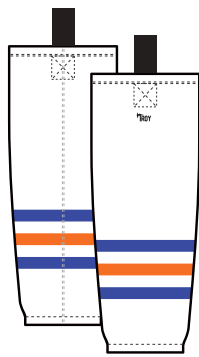

EDMONTON
SK-300-3242

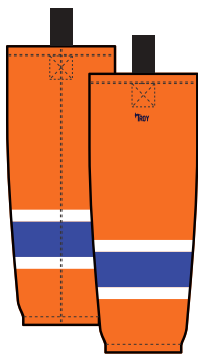

EDMONTON
SK-300-3243



FLORIDA
SK-300-3381

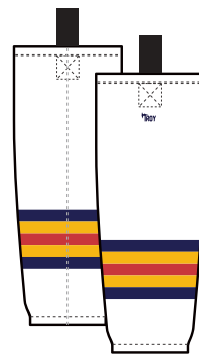

FLORIDA
SK-300-3382

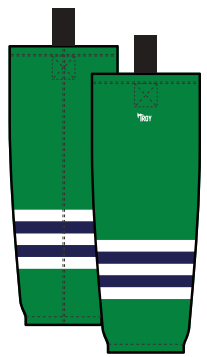

HARTFORD
SK-300-3471

SK-300 PRO PERFORMANCE / PERFORMANCE PRO

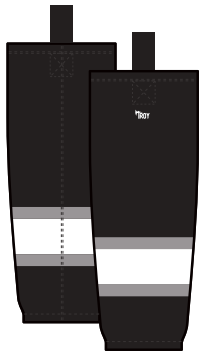

*LOS ANGELES
SK-300-3121*

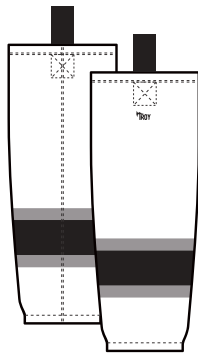

*LOS ANGELES
SK-300-3122*

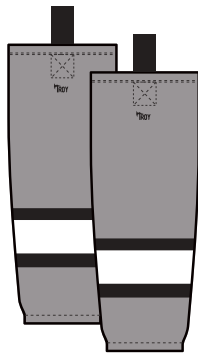

*LOS ANGELES
SK-300-3123*

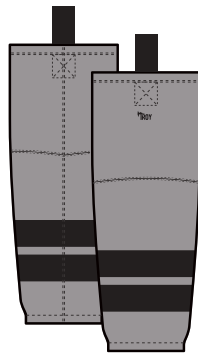

*LOS ANGELES
SK-300-3126*



*MINNESOTA
SK-300-3721*

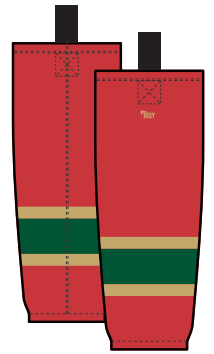

*MINNESOTA
SK-300-3722*

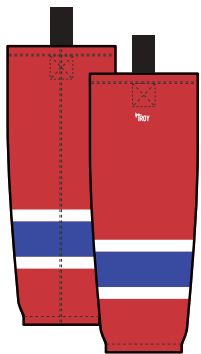

*MONTREAL
SK-300-3051*

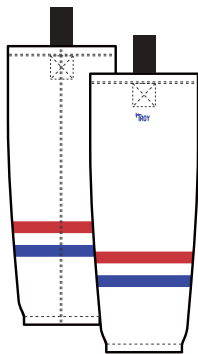

*MONTREAL
SK-300-3052*

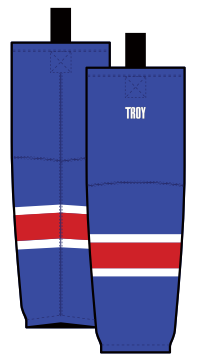

*MONTREAL
SK-300-3053*

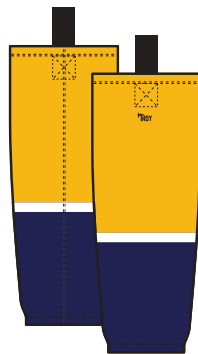

*NASHVILLE
SK-300-3683*

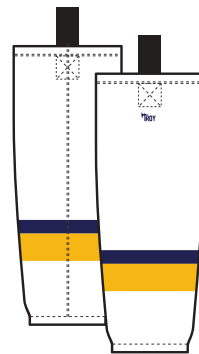

*NASHVILLE
SK-300-3684*

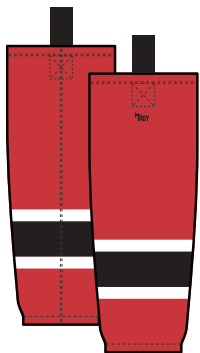

*NEW JERSEY
SK-200-3351*

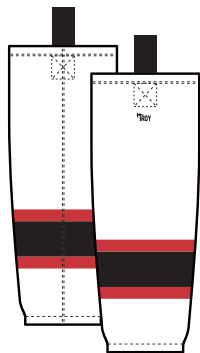

*NEW JERSEY
SK-300-3352*

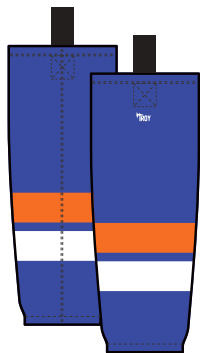

*NY ISLANDERS
SK-300-3153*

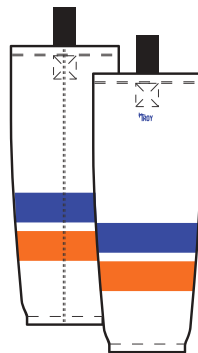

*NY ISLANDERS
SK-300-3154*

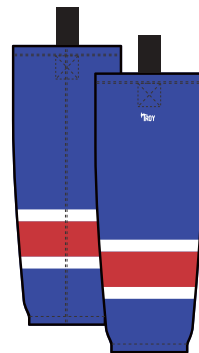

*NY RANGERS
SK-300-3031*

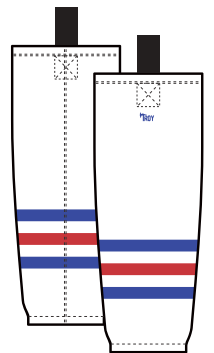

*NY RANGERS
SK-300-3032*

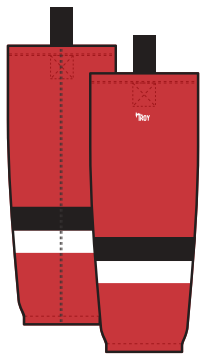

*OTTAWA
SK-300-3221*

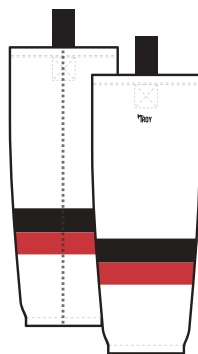

*OTTAWA
SK-300-3222*



*OTTAWA
SK-300-3225*



*OTTAWA
SK-300-3227*

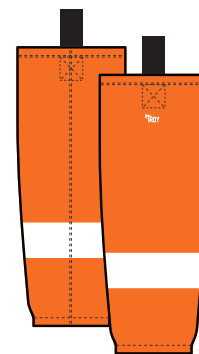

*PHILADELPHIA
SK-300-3111*

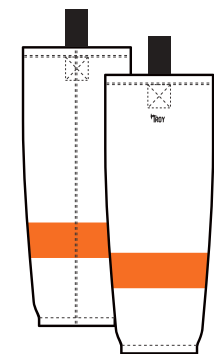

*PHILADELPHIA
SK-300-3112*

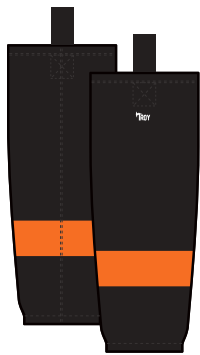

PHILADELPHIA
SK-300-3113

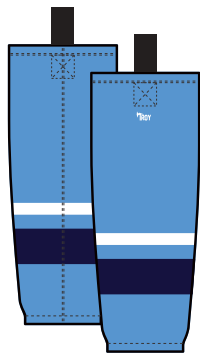

PITTSBURGH
SK-300-3333

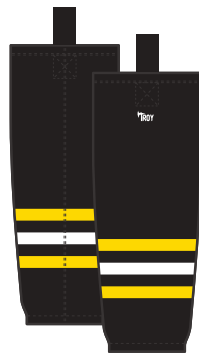

PITTSBURGH
SK-300-3334

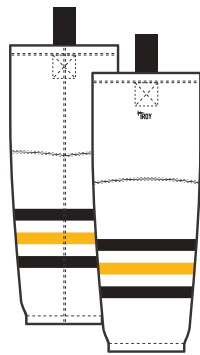

PITTSBURGH
SK-300-3335



PITTSBURGH
SK-300-3336

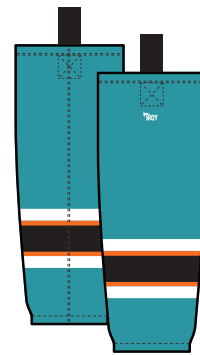

SAN JOSE
SK-300-3201

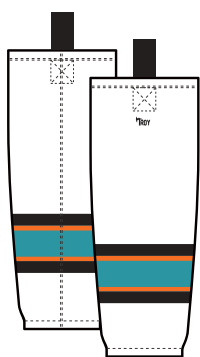

SAN JOSE
SK-300-3202

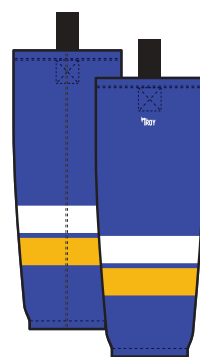

ST-LOUIS
SK-300-3091

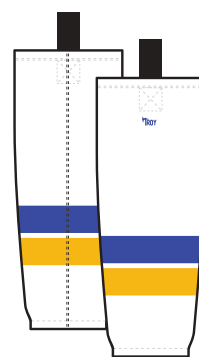

ST-LOUIS
SK-300-3092

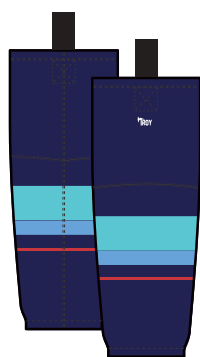

SEATTLE
SK-300-3751

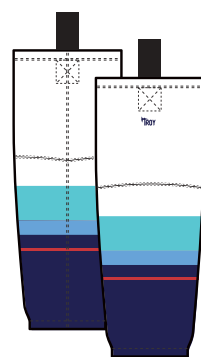

SEATTLE
SK-300-3752



TAMPA BAY
SK-300-3231

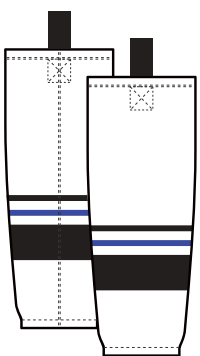

TAMPA BAY
SK-300-3232

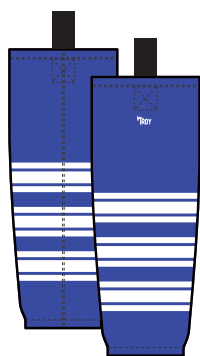

TORONTO
SK-300-3041

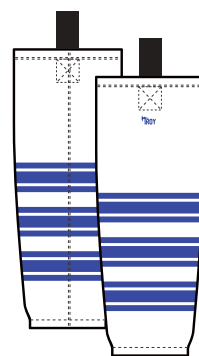

TORONTO
SK-300-3042

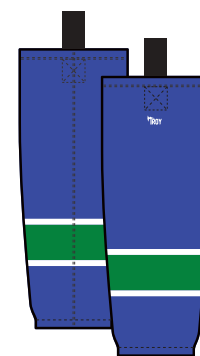

VANCOUVER
SK-300-3343

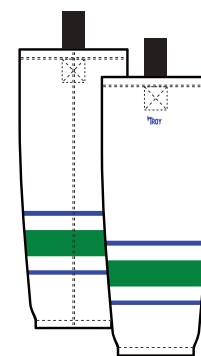

VANCOUVER
SK-300-3344

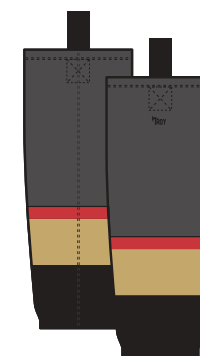

VEGAS
SK-300-3731

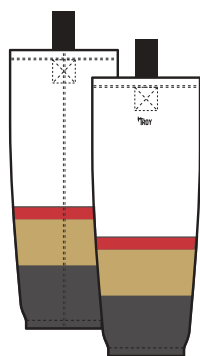

VEGAS
SK-300-3732



WASHINGTON
SK-300-3271

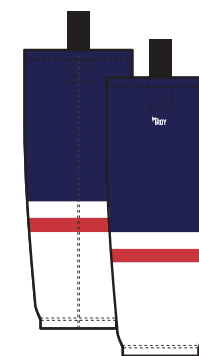

WASHINGTON
SK-300-3272

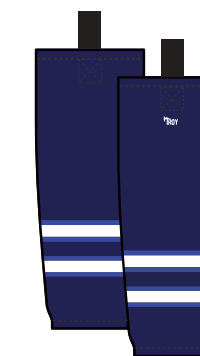

WINNIPEG
SK-300-3601

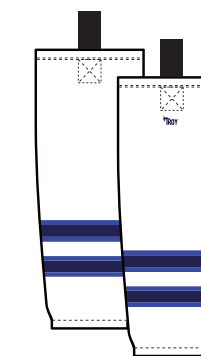

WINNIPEG
SK-300-3602

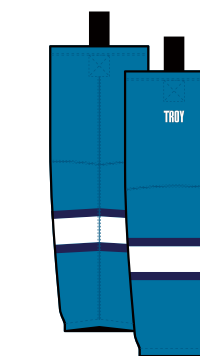

WINNIPEG
SK-300-3603

BB-680 3-BUTTON / 3-BOUTONS

- 100% lightweight polyester
- Durable
- Contrasting colors

- 100% polyester léger
- Durable
- Couleurs contrastantes

SIZES // TAILLES

JR: S, M, L, XL,

SR: S, M, L, XL, 2XL, 4XL



1404 ROYAL/ROYAL



3413 SILVER/ARGENT



1613 GOLD/OR



0816 GREEN/VERT



1322 BLACK/NOIR



0304 RED/ROUGE

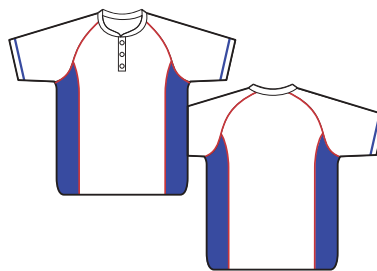

0414 WHITE/BLANC



1703 NAVY/MARINE



2213 ORANGE/ORANGE

BB680



TJ-675 PANT SHELLS / GAINES



- 300gsm polyester shell
- Elastic ribbing on front, back & inseam
- Belt with clip attachment
- Polyester de 300gsm
- Tissu côtelé extensible sur le devant, dos et l'entrejambe
- Ceinture avec fermeture à bouton pression

SIZES // TAILLES

JR: S, M, L, XL,
SR: S, M, L, XL, 2XL, G INT, G XL



With embroidered logo
-Set up fees included

Avec logo brodé
-Frais de mise en place
inclus



03 RED/ROUGE



13 BLACK/NOIR



14 ROYAL/ROYAL



17 NAVY/MARINE

TJ-910 WINTER JACKET / MANTEAU D'HIVER



13 BLACK/NOIR

- 100% polyester shell and fill
- Snap-on hood
- Embroidery available

- Extérieur et remplissage 100% polyester
- Capuche encliquetable
- Broderie disponible

*Limited stock
*Inventaire limité



17 NAVY/MARINE

SIZES // TAILLES

SR: S, M, L, XL, 2XL, 3XL

TA-054 WET GEAR



Dryer Rack

- Dries equipment in hours
- Preserves and aerates equipment
- Saves space - Organizes
- Easy no tools required setup
- Stands 57" high

Support de séchage

- Sèche l'équipement en quelques heures
- Préserve et aère l'équipement
- Économise et organise l'espace
- Installation facile
- Hauteur de 57"

TA-400 WET GEAR



Deluxe Locker Dryer

- Equipment dries within hours
- Metal body
- Preserves and aerates equipment
- Never again forget a piece of equipment
- One size fits all - Novice to Junior
- Stands 72" high

Support de vestiaire deluxe

- Séchage rapide
- Fait de métal
- Préserve et aère l'équipement
- N'oubliez plus jamais une pièce d'équipement
- Taille unique - Novice à Junior
- Hauteur de 72"



A C U T A B O V E U N E C O U P E S U P E R I E U R E

CUSTOM





CUSTOM / SUR MESURE

SHOWCASE YOUR **BRAND!**

EVERY TROY APPAREL GARMENT CREATED BECOMES
A PLAYER'S *EXCLUSIVE* JERSEY

Keep a traditional look with Cut & Sew uniforms and embellish them your way, or Sublimate them to showcase the versatility of your imagination.

PROMOUVOIR VOTRE '**BRAND**'!

CHAQUE VÊTEMENT CRÉE PAR TROY APPAREL DEVIENT UN
CHANDAIL DE HOCKEY UNIQUE D'UN JOUEUR

Gardez un look traditionnel avec les ensembles Cut & Sew et embellissez-les à votre façon, ou Sublimez-les pour mettre en valeur la polyvalence de votre imagination.



TJ-310 CUSTOM / SUR MESURE

- Cut & Sew blank jersey
- 190 gsm polyester fabric
- Double shoulder and elbows
- Multiple collar possibilities
- Any striping pattern available

NOTE: Refer to pages 60-63 for details

- Chandails vierge sur mesure
- Tissus polyester 190 gsm
- Épaules et coudes doublés
- Options de collets multiples
- Tout motifs de rayures disponible

NOTE: Referez vous aux pages 60-63 pour les details

DELIVERY TIME : 4 WEEKS

DÉLAI DE LIVRAISON : 4 SEMAINES

SIZES // TAILLES

JR: XS, S/M, L/XL, G, INT. G

SR: S, M, L, XL, 2XL, G



TJ-310



SK-310 PRO SOCKS / BAS



- 190 gsm fabric
- Elasticized ankle
- Two velcro straps
- Tissus 190 gsm
- Cheville élastique
- Attaches en velcro

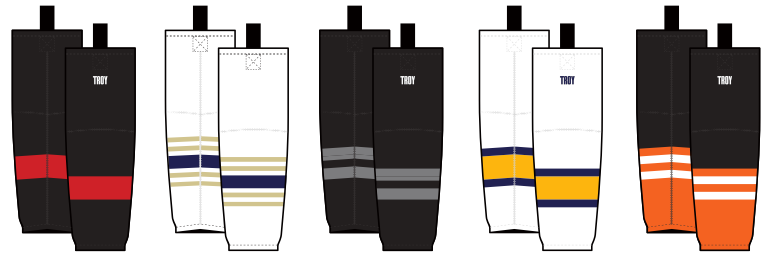

SIZES // TAILLES

18", 20", 22", 24",
26", 28", 30"

DELIVERY TIME : 4 WEEKS

DÉLAI DE LIVRAISON : 4 SEMAINES

TP-310 SHELLS / GAINES

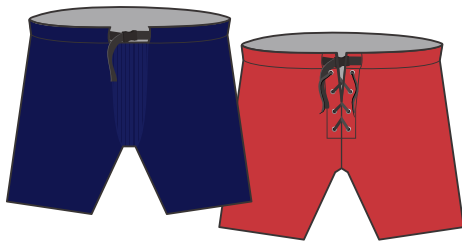

- 300 gsm nylon fabric
- Belt with clip lock
- Lace attachment or ribbed elastic at crotch available
- Includes striping

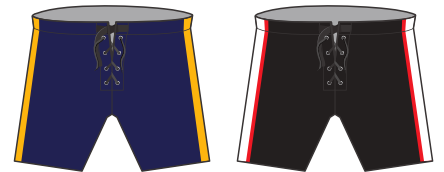

DELIVERY TIME : 4-6 WEEKS
DÉLAI DE LIVRAISON :
4-6 SEMAINES

- Tissus en nylon 300 gsm
- Cordon de serrage
- Attachement en lâcet ou elastic
- Rayures sur les cotés incluses

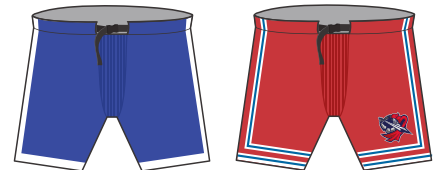

SIZES // TAILLES

JR: S, M, L, XL,
SR: S, M, L, XL, 2XL, G MED, G XL

TP-315 With embroidered logo

TP-315 Avec logo brodé



NOTE: ALL IMAGES ARE EXAMPLES FROM TROY APPAREL REPERTOIRE
NOTE: TOUTES LES IMAGES SONT DES EXEMPLES DU RÉPERTOIRE TROY APPAREL

TJ-601 GAME / MATCH

- Sublimated jersey
- Exclusive and personalized designs
- 190 gsm polyester fabric
- Multiple collar possibilities
- Double shoulder and elbows

NOTE: Refer to pages 60-63 for details



- Chandail sublimé
- Designs exclusifs et personnalisés
- Tissus polyester 190 gsm
- Multiples options de collets
- Épaules et coudes doublés

NOTE: Referez vous aux pages 60-63 pour les details

DELIVERY TIME : 4-6 WEEKS

DÉLAI DE LIVRAISON :

4-6 SEMAINES

SIZES // TAILLES

JR: XS, S/M, L/XL, G, INT. G

SR: S, M, L, XL, 2XL, G



NOTE: ALL IMAGES ARE EXAMPLES FROM TROY APPAREL REPERTOIRE

NOTE: TOUTES LES IMAGES SONT DES EXEMPLES DU RÉPERTOIRE TROY APPAREL

TJ-602 PRO GAME / PRO MATCH

- Sublimated jersey
- Exclusive and personalized designs
- 220 gsm heavyweight polyester fabric
- Multiple collar possibilities
- Double shoulder and elbows
- Fight strap optional

NOTE: Refer to pages 60-63 for details

DELIVERY TIME : 4-6 WEEKS

DÉLAI DE LIVRAISON :

4-6 SEMAINES

- Chandail sublimé
- Designs exclusifs et personnalisés
- Tissus robuste polyester 220 gsm
- Multiples options de collets
- Épaules et coudes doublés
- Lanière de combat sur demande

NOTE: Referez vous aux pages 60-63 pour les details

SIZES // TAILLES

JR: XS, S/M, L/XL, G, INT. G

SR: S, M, L, XL, 2XL, G



NOTE: ALL IMAGES ARE EXAMPLES FROM TROY APPAREL REPERTOIRE
NOTE: TOUTES LES IMAGES SONT DES EXEMPLES DU RÉPERTOIRE TROY APPAREL

TJ-625 ELITE / ÉLITE

- Sublimated jersey with embroidered front logo
- Professional Pro look
- Exclusive and personalized designs
- 190 or 220 gsm polyester fabric
- Multiple collar possibilities
- Double shoulder and elbows

NOTE: Refer to pages 60-63 for details

- Chandail sublimé avec broderie devant
- Apparence professionnelle
- Designs exclusifs et personnalisés
- Tissus polyester 190 ou 220 gsm
- Multiples options de collets
- Épaules et coudes doublés

NOTE: Referez vous aux pages 60-63 pour les details



DELIVERY TIME : 5-6 WEEKS

DÉLAI DE LIVRAISON :

5-6 SEMAINES

SIZES // TAILLES

JR: XS, S/M, L/XL, G, INT. G

SR: S, M, L, XL, 2XL, G



NOTE: ALL IMAGES ARE EXAMPLES FROM TROY APPAREL REPERTOIRE

NOTE: TOUTES LES IMAGES SONT DES EXEMPLES DU RÉPERTOIRE TROY APPAREL

TJ-80 HYBRIDS / HYBRIDES



- Sublimated cut & sew hybrid jersey (front and back panels only)
- Cost-effective option
- 190 gsm polyester fabric only
- Combinaison coupé-cousu et sublimation (panneau devant et dos seulement)
- Option économique
- Tissus polyester 190 gsm seulement

SIZES // TAILLES

JR: XS, S/M, L/XL, G, INT. G
SR: S, M, L, XL, 2XL, G

DELIVERY TIME : 4 WEEKS

DÉLAI DE LIVRAISON :
4 SEMAINES

*WITH SUBLIMATED
SHOULDERS

*AVEC ÉPAULES SUBLIMÉS

TJ-300 HYBRIDS / HYBRIDES



- Sublimated jersey with cut & sew panels
 - 190 gsm polyester fabric only
- NOTE: Refer to pages 60-63 for details

- Chandail sublimé avec panneaux coupé-cousu
 - Tissus polyester 190 gsm seulement
- NOTE: Referez vous aux pages 60-63 pour les details

SIZES // TAILLES

JR: XS, S/M, L/XL, G, INT. G
SR: S, M, L, XL, 2XL, G

DELIVERY TIME : 4-6 WEEKS

DÉLAI DE LIVRAISON :
4-6 SEMAINES

KITS / ENSEMBLES

TP-670 SHELLS / GAINES

- Sublimated Pant shells
NOTE: Refer to pages 43 for details

- Gaines sublimés
NOTE: Referez vous à la page 43 pour les detailes



SK-640 SOCKS / BAS

- Sublimated socks 190gsm
- Bas sublimés 190gsm

SK-642 SOCKS / BAS

- Sublimated PRO socks 220gsm
- Bas PRO sublimés 220gsm

NOTE: Refer to pages 32 for details

NOTE: Referez vous à la page 32 pour les detailes



DELIVERY TIME : 4 WEEKS
DÉLAI DE LIVRAISON :
4 SEMAINES



TJ-600 SPECIAL EVENTS / ÉVÉNEMENTS SPÉCIAUX

- All Star, Alumni, Cancer Research, Christmas, Remembrance Day.
 - 190 gsm polyester fabric only
 - No double shoulders and elbows
- NOTE: Refer to pages 60-63 for details

- Matches Étoiles, Anciens, Recherches au cancer, Noel, Jour de Souvenir.
 - Tissus polyester 190 gsm seulement
 - Sans épaules et coudes doublés
- NOTE: Referez vous aux pages 60-63 pour les details



SIZES // TAILLES

JR: XS, S/M, L/XL, G, INT. G
SR: S, M, L, XL, 2XL, G



DELIVERY TIME : 4 WEEKS
DÉLAI DE LIVRAISON :
4 SEMAINES

TJ-666 REVERSIBLE / RÉVERSIBLE



- Sublimated and doubled fabric
 - 120 gsm polyester fabric only
 - No double shoulders and elbows
 - V-neck or V-neck with insert only
- NOTE: Refer to pages 60-63 for details

- Sublimé au tissu doublé
- Tissus polyester 120 gsm seulement
- Sans épaules et coudes doublés
- Collet en V ou collet en V avec empiècement seulement

NOTE: Referez vous aux pages 60-63 pour les details

SIZES // TAILLES

JR: XS, S/M, L/XL, G, INT. G

SR: S, M, L, XL, 2XL, G

DELIVERY TIME : 4-6 WEEKS

DÉLAI DE LIVRAISON :

4-6 SEMAINES



TJ-668 PINNIES / DOSSARDS BASKETBALL

SK-645 SOCKS / BAS

TJ-610 DEK HOCKEY / HOCKEY DEK



- Exclusive designs
- Breathable fabric options available
- Shorts and Goalie sizes available
- Designs exclusifs
- Plusieurs tissus respirants disponibles
- Shorts et grandeurs gardien disponible

SIZES // TAILLES

JR: S/M, L/XL, G
SR: S, M, L, XL, 2XL, G

TJ-611 SHORTS / SHORTS

DELIVERY TIME : 4 WEEKS

DÉLAI DE LIVRAISON :
4 SEMAINES



BB-650 BASEBALL / BASEBALL



- 100% lightweight polyester
- Durable

- 100% polyester léger
- Durable

BB-650 FULL BUTTON / CHEMISE

BB-651 V-NECK / COLLET EN V

BB-652 2-BUTTON / 2 BOUTONS

BB-653 3-BUTTON / 3 BOUTONS

SIZES // TAILLES

JR: S, M, L, XL,

SR: S, M, L, XL, 2XL

DELIVERY TIME : 4 WEEKS

DÉLAI DE LIVRAISON :

4 SEMAINES





TJ-620 HOODIES / CHANDAILS À CAPUCHONS



- Exclusive designs
- Breathable fabric options available
- Available with laces or cord
- Designs exclusifs
- Plusieurs tissus respirants disponibles
- Disponible avec lacets ou corde

DELIVERY TIME : 4-6 WEEKS
 DÉLAI DE LIVRAISON :
 4-6 SEMAINES

SIZES // TAILLES

JR: S, M, L, XL
 SR: S, M, L, XL, 2XL



HOODIE
 CHANDAIL À CAPUCHON



MULTI COLOR LOGO
 LOGO MULTI COULEUR

2-COLOR HOODIE
 CHANDAIL À CAPUCHON 2-COULEURS



MULTI COLOR LOGO
 LOGO MULTI COULEUR

VARIOUS / VARIÉ



- 100% lightweight polyester
- 100% polyester léger

TJ-611 SHORTS / SHORTS

DELIVERY TIME : 4 WEEKS
DÉLAI DE LIVRAISON :
4 SEMAINES

TJ-631 SOCCER Jersey / chandail



- 100% lightweight polyester
- 100% polyester léger

TJ-611 SHORTS / SHORTS

LONG SLEEVE / MANCHES LONGUE

DELIVERY TIME : 4 WEEKS
DÉLAI DE LIVRAISON :
4 SEMAINES

TJ-632 VOLLEYBALL Jersey / chandail



- 100% lightweight polyester
- 100% polyester léger

TJ-611 SHORTS / SHORTS

DELIVERY TIME : 4 WEEKS
DÉLAI DE LIVRAISON :
4 SEMAINES

TJ-633 FLAG FOOTBALL Jersey / chandail

VARIOUS / VARIÉ



- 100% lightweight polyester
- 100% polyester léger

TJ-611 SHORTS / SHORTS

REVERSIBLE



TJ-634 BASKETBALL
Jersey / chandail

DELIVERY TIME : 4 WEEKS
DÉLAI DE LIVRAISON : 4 SEMAINES

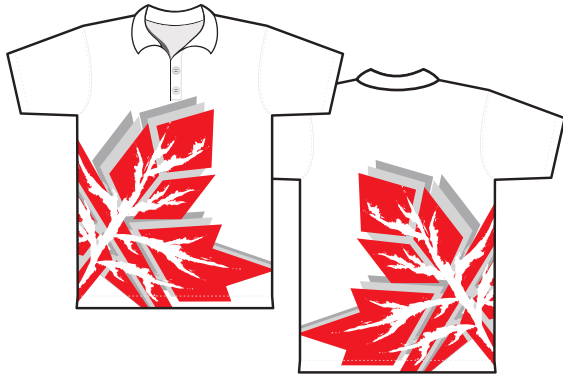

- 100% lightweight polyester
- 100% polyester léger

DELIVERY TIME : 4 WEEKS
DÉLAI DE LIVRAISON : 4 SEMAINES

TJ-635 POLO



- 100% lightweight polyester
NOTE: Refer to pages 60-63 for details

- 100% polyester léger
NOTE: Referez vous aux pages 60-63 pour les details

DELIVERY TIME : 4-6 WEEKS
DÉLAI DE LIVRAISON : 4-6 SEMAINES

TJ-601 RINGETTE

VARIOUS / VARIÉ



TJ-637 BOX LACROSSE
Jersey / chandail

- 100% lightweight polyester
NOTE: Refer to pages 60-63
for details

- 100% polyester léger
NOTE: Referez vous aux pages
60-63 pour les details

DELIVERY TIME : 4-6 WEEKS
DÉLAI DE LIVRAISON :
4-6 SEMAINES



TJ-638 FIELD LACROSSE
Jersey / chandail

- 100% lightweight polyester
NOTE: Refer to pages 60-63
for details

- 100% polyester léger
NOTE: Referez vous aux pages
60-63 pour les details

DELIVERY TIME : 4-6 WEEKS
DÉLAI DE LIVRAISON :
4-6 SEMAINES

ACTIVE WEAR // VÊTEMENTS DE SPORT

COTTON T-SHIRT
T-SHIRT EN COTON



INCLUDING MULTI COLOR LOGO
INCLUANT LOGO MULTI COULEURS

POLYESTER T-SHIRT
T-SHIRT EN POLYESTER



INCLUDING MULTI COLOR LOGO
INCLUANT LOGO MULTI COULEURS

POLO
POLO



INCLUDING EMBROIDERED LOGO
AND SET UP FEES
INCLUANT LOGO BRODÉ ET FRAIS
DE MISE EN PLACE

DELIVERY TIME : 2 WEEKS
DÉLAI DE LIVRAISON : 2 SEMAINES



TUQUE // TUQUE



COTTON TUQUE
TUQUE EN COTON



EMBROIDERED TUQUE
TUQUE BRODÉ



EMBROIDERED TUQUE WITH POM-POM
TUQUE BRODÉ AVEC POMPON



DELIVERY TIME : 4 WEEKS
DÉLAI DE LIVRAISON : 4 SEMAINES

CAMP PACK // SAC DE CAMP



- Includes bag, T-shirt, shorts and socks
- Heat transfer logos
- Long sleeve T-shirt available

- Inclues sac, T-shirt, shorts et bas
- Logos par transfère thermique
- T-shirt à manches longues disponible



BLACK 13 NOIR



NAVY 17 MARINE

STARTER KIT // KIT DE DÉPART

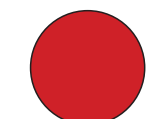
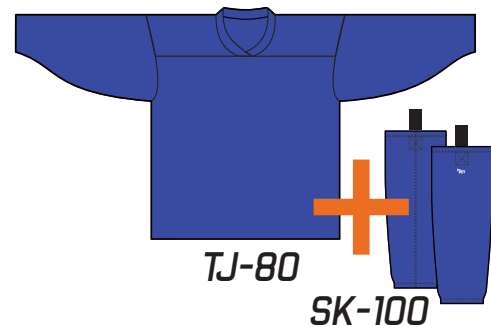

RED 03 ROUGE

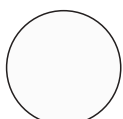

WHITE 04 BLANC



BLACK 13 NOIR



ROYAL 14 ROYAL



NAVY 17 MARINE

BAGS / SACS



- Polyvinyl fabric
- Heavy duty zippers; window ID; PVC feet
- Embroidered on one or two sides
- Custom strapping

- Tissus polyvinyl
- Fermetures éclair robustes; fenêtre d'identification; pieds en PVC
- Brodé sur un ou deux côtés
- Sangles personnalisées

SIZES // TAILLES

JR: 30in x 18in x 15in

SR: 35in x 20in x 15in

Goalie/Gardien: 42in x 20in x 20in

Coach: 22in x 14in x 13in

Backpack/Sac à dos:

16in x 13in x 8in

Toiletry bag/Trousse de toilette:

12in x 6in x 5in

BLACK	SKY BLUE	NAVY BLUE
WHITE	ORANGE	KELLY GREEN
GOLD	ROYAL BLUE	RED
GREY	VEGAS GOLD	FOREST

JUNIOR PLAYER
JOUEUR JUNIOR



SENIOR PLAYER
JOUEUR SENIOR



GOALIE
GARDIEN



COACH
ENTRAINEUR



TOILETRY BAG
TROUSSE DE
TOILETTE



DELIVERY TIME : 8 WEEKS
DÉLAI DE LIVRAISON :
8 SEMAINES



THE NEW
REVOLUTION
IN
HOCKEY

TJ-80 / TJ-300 SPECIFICATIONS / SPÉCIFICATIONS

NOTE : Refer to SPECIFICATIONS page when ordering sublimated apparel.

REMARQUE : Référez vous à la page SPÉCIFICATIONS quand vous placez une commande sublimation.

FABRICS // TISSUS



HOCKEY; RINGETTE; LACROSSE: 120 GSM (Reversibles), 190 GSM, 220 GSM

PATTERNS // PATRONS

NOTE: Straight bottom option available upon request.

NOTE : DISPONIBLE.

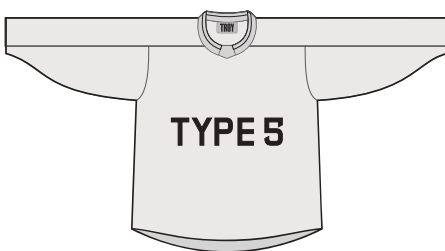
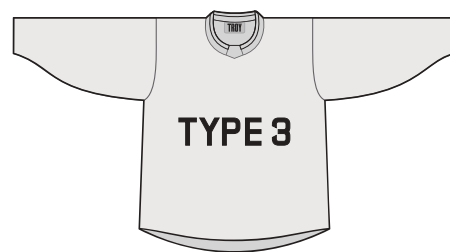
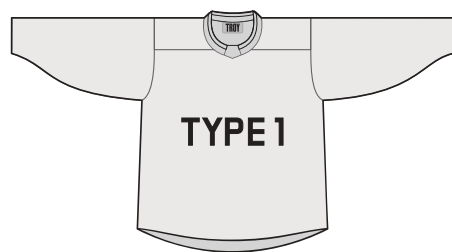

COLLARS // COLLETS

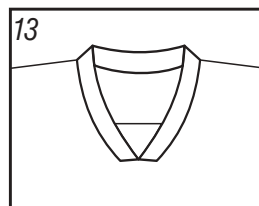
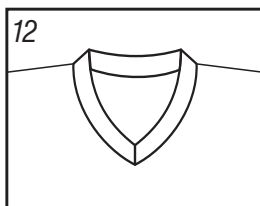
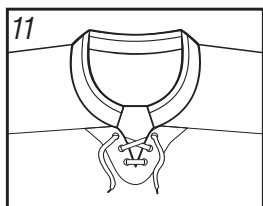
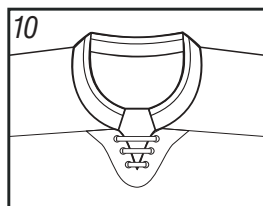
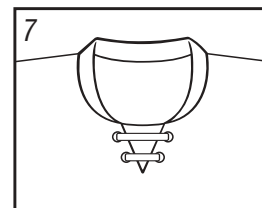
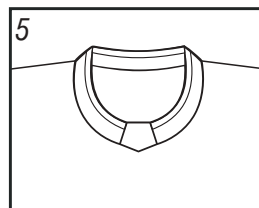
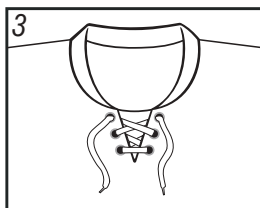
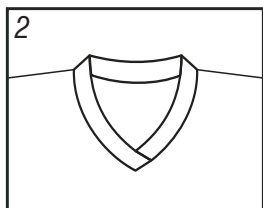
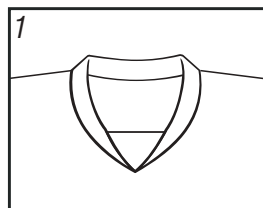

STRIPING DETAILS // DÉTAILLES DE RAYURES

NOTE : Striping details below are for reference only.

NOTE : Les types de rayures indiquées sont seulement que pour votre référence..

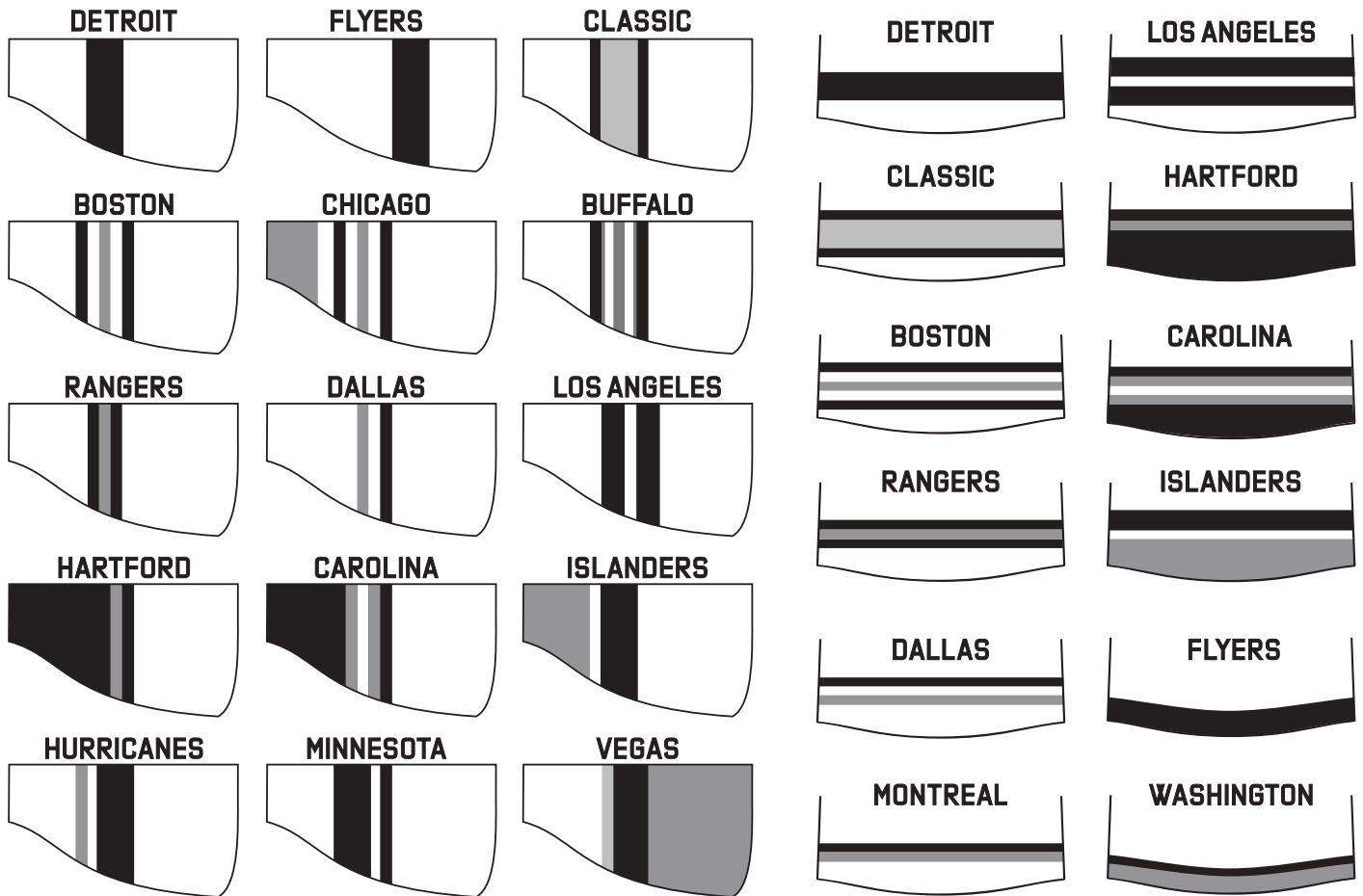

SIZE CHART // TABLEAU DES TAILLES

JERSEY / CHANDAIL SIZES IN INCHES

	JUNIOR					SENIOR					
	XS	S/M	L/XL	G	INT G	S	M	L	XL	XXL	SRG
A	15.5	18.0	20.0	25.0	27.0	21.0	23.0	25.0	27.0	29.0	32.0
B	22.0	26.0	28.0	30.0	31.0	30.0	31.0	32.0	33.0	34.5	33.5
C	22.0	26.0	27.5	31.0	33.0	32.0	33.0	34.0	35.5	36.0	34.0
D	8.5	10.5	11.0	13.0	13.5	11.5	12.0	13.0	13.5	14.0	16.5
E	4.0	4.5	4.5	8.0	8.0	5.5	5.5	6.0	6.5	7.0	8.0

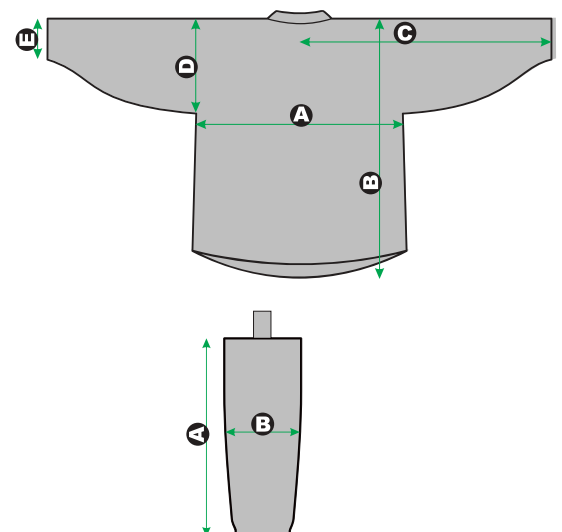

SOCK / BAS (PRO PERFORMANCE) SIZES IN INCHES

	JUNIOR	INTERMEDIATE	SENIOR
A	20-22	24-26	28-30
B*	16	18	20

*NOTE: 'B' IS CIRCUMFERENCE

TJ-80 / TJ-300 SPECIFICATIONS / SPÉCIFICATIONS

NUMBERS // NUMEROS

NOTE : All NHL, NFL and MLB number styles are available. Custom fonts are accepted only if provided.

REMARQUE : Tous les modèles de chiffres LNH, LNF et LMB sont disponibles. Les polices personnalisées ne sont acceptées que si elles sont fournies.

Available TROY fonts / Polices TROY disponible

TN-01	1 2 3 4 5 6 7 8 9 10	TN-02	1 2 3 4 5 6 7 8 9 10
TN-03	1 2 3 4 5 6 7 8 9 10	TN-04	1 2 3 4 5 6 7 8 9 10
TN-05	1 2 3 4 5 6 7 8 9 10	TN-06	1 2 3 4 5 6 7 8 9 10
TN-07	1 2 3 4 5 6 7 8 9 10	TN-08	1 2 3 4 5 6 7 8 9 10
TN-09	1 2 3 4 5 6 7 8 9 10	TN-10	1 2 3 4 5 6 7 8 9 10
TN-11	1 2 3 4 5 6 7 8 9 10	TN-12	1 2 3 4 5 6 7 8 9 10

COLORS // COULEURS

IMPORTANT : Colors will vary due to the sublimation process.

IMPORTANT : Les couleurs varieront en raison du processus de la sublimation.

BLACK / NOIR	WHITE / BLANC	CHARCOAL / CHARBON	VEGAS GREY / GRIS VEGAS	GREY / GRIS	LIGHT GREY / GRIS PÂLE
MIDNIGHT BLUE	NAVY / MARINE	DARK BLUE / BLEU FONCÉ	ROYAL BLUE / BLEU ROYAL	MID BLUE / BLEU MOYEN	SKY BLUE / BLEU CIEL
ICE / GLACE	FOREST / FORÊT	KELLY GREEN / VERT KELLY	LIME / LIME	AQUA / AQUA	TEAL / SARGELLE
SEATTLE BLUE / BLEU SEATTLE	GOLD / OR	YELLOW / JAUNE	VEGAS GOLD / OR VEGAS	OLD GOLD / OR VIEUX	VEGAS TAN / BRUN VEGAS
BEIGE / BEIGE	BROWN / BRUN	PURPLE / VIOLET	EGGPLANT / AUBERGINE	MAROON / BORDEAUX	HARVARD / HARVARD
RED / ROUGE	LIGHT RED / ROUGE PÂLE	HOT PINK / ROSE VIF	PINK / ROSE	ORANGE / ORANGE	BURNT ORANGE / ORANGE BRÛLÉ



TROY

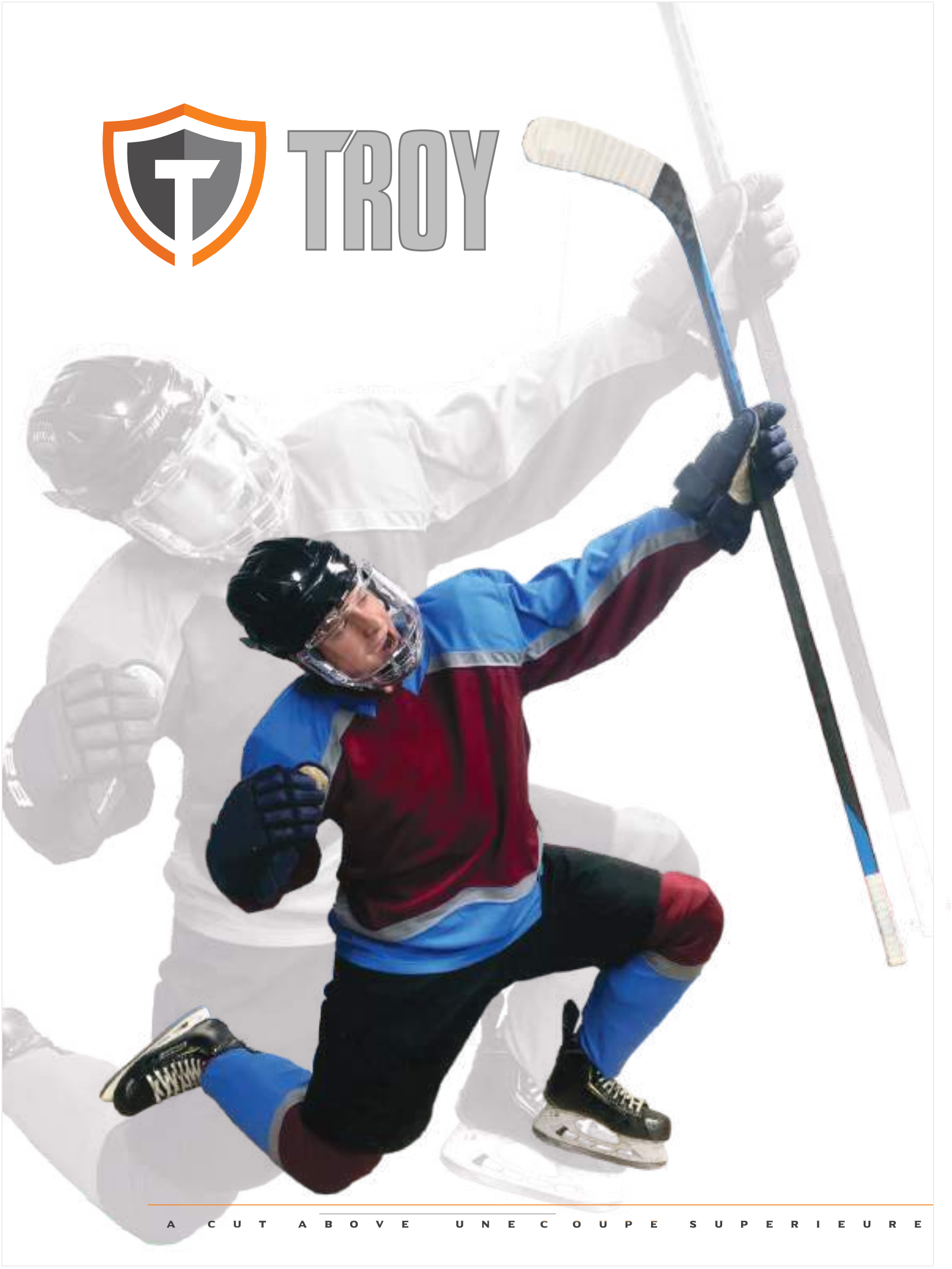

A C U T A B O V E U N E C O U P E S U P E R I E U R E

TROY APPAREL INC.

**10175 AVE HÔTEL-DE-VILLE
MONTREAL-NORD
QUEBEC, CANADA H1H 3V3**

Tel: 514-321-0080 / FAX: 514-328-7165 / orders@troyhockey.com